



Development of Best Practices for Inspection of PT Bridges in Minnesota

Minnesota
Department of
Transportation

**RESEARCH
SERVICES**

Office of
Policy Analysis,
Research &
Innovation

Andrea Schokker, Principal Investigator
Department of Civil Engineering
University of Minnesota Duluth

April 2012

Research Project
Final Report 2012-09

Your Destination... Our Priority



To request this document in an alternative format, call Bruce Lattu at 651-366-4718 or 1-800-657-3774 (Greater Minnesota); 711 or 1-800-627-3529 (Minnesota Relay). You may also send an e-mail to bruce.lattu@state.mn.us. (Please request at least one week in advance).

Technical Report Documentation Page

1. Report No. MN/RC 2012-09	2.	3. Recipients Accession No.	
4. Title and Subtitle Development of Best Practices for Inspection of PT Bridges in Minnesota		5. Report Date April 2012	
		6.	
7. Author(s) Kyle Matthew Berg, Andrea J. Schokker		8. Performing Organization Report No.	
9. Performing Organization Name and Address Department of Civil Engineering University of Minnesota Duluth 1405 University Drive Duluth, MN 55812		10. Project/Task/Work Unit No. CTS Project #2011018	
		11. Contract (C) or Grant (G) No. (c) 89261 (wo) 192	
12. Sponsoring Organization Name and Address Minnesota Department of Transportation Research Services 395 John Ireland Blvd, MS 330 St. Paul, MN 55155		13. Type of Report and Period Covered	
		14. Sponsoring Agency Code	
15. Supplementary Notes http://www.lrrb.org/pdf/201209.pdf			
16. Abstract (Limit: 250 words) <p>This report focuses on post-tensioned bridges built in Minnesota prior to 2003. The scope is limited to providing a targeted check of bridges that are most likely to have grouting related corrosion problems based on a review of plans and inspection notes. The project consisted of three phases: 1) review of plans and inspection reports of 40 post-tensioned bridges constructed prior to 2003, 2) selection of 10 bridges for a limited onsite inspection of the exterior of the bridge, and 3) invasive inspection of three select bridges. The bridges were selected to represent different bridge construction types to provide a spot check of the post-tensioned bridge inventory in Minnesota. One of the three bridges has corrosion and voids due to poor grouting, one has major corrosion problem related to construction issues (but appears to have good grout), and one showed no tendon corrosion or grouting problems during the invasive spot checks.</p> <p>Recommendations are given at the end of the report specific to the bridges that were investigated as well as for a general inspection plan for post-tensioned bridges in Minnesota. A concise guide for bridge inspection staff is provided that is specific to post-tensioned bridges.</p>			
17. Document Analysis/Descriptors Post-tensioned bridges, Prestressed concrete bridges, Posttensioning, Grout, Grout bleed, Corrosion, Post-tensioned Tendon invasive inspection, Inspection, Recommendations, Guidelines		18. Availability Statement No restrictions. Document available from: National Technical Information Services, Alexandria, Virginia 22312	
19. Security Class (this report) Unclassified	20. Security Class (this page) Unclassified	21. No. of Pages 213	22. Price

Development of Best Practices for Inspection of PT Bridges in Minnesota

Final Report

Prepared by:

Kyle Matthew Berg
Andrea J. Schokker

Department of Civil Engineering
University of Minnesota Duluth

April 2012

Published by:

Minnesota Department of Transportation
Research Services
395 John Ireland Boulevard, MS 330
St. Paul, Minnesota 55155-1899

This report represents the results of research conducted by the authors and does not necessarily represent the views or policies of the Minnesota Department of Transportation or the University of Minnesota Duluth. This report does not contain a standard or specified technique.

The authors, the Minnesota Department of Transportation, and the University of Minnesota Duluth do not endorse products or manufacturers. Any trade or manufacturers' names that may appear herein do so solely because they are considered essential to this report.

Acknowledgments

The authors wish to thank the Minnesota Department of Transportation for support of this project. The technical support and guidance from Paul Kivisto and Ed Lutgen, and the logistical support from Shirlee Sherkow are greatly appreciated. It was a pleasure to work with each of you on this project.

Table of Contents

Chapter 1	Background.....	1
1.1	Post-Tensioning Basics	1
1.2	Post-Tensioning Grout	3
Chapter 2	Literature Review.....	5
2.1	Case Studies of Grouting Related Problems	5
2.1.1	The Niles Channel Bridge.....	5
2.1.2	The Mid-Bay Bridge.....	6
2.1.3	The Sunshine Skyway Bridge.....	8
2.2	Current Status.....	9
Chapter 3	Inspection and Testing.....	10
3.1	MnDOT Current Bridge Inspection Procedures.....	10
3.2	Invasive Investigation Performed by VStructural.....	12
3.3	Acid Soluble Chloride Testing.....	15
Chapter 4	Evaluation of Post-Tensioned Bridge Inventory.....	17
4.1	Summary of Bridges Selected for Visual Inspections.....	20
4.1.1	Bridge 27611.....	20
4.1.2	Bridge 27262 (LRT)	22
4.1.3	Bridge 02037 E	24
4.1.4	Bridge 02037 W	25
4.1.5	Bridge 9350 (Dartmouth).....	27
4.1.6	Bridge 27719.....	28
4.1.7	Bridge 69818 N.....	30
4.1.8	Bridge 69818 S	33
4.1.9	Bridge 02034.....	34
4.1.10	Bridge 9030 (Blatnik)	36
4.1.11	Bridge 70037.....	37
4.1.12	Bridge 70038.....	39
4.1.13	Bridge 27547.....	40
Chapter 5	Visual Inspection of Select PT Bridges in Minnesota	42
5.1	Bridge 27262 (LRT).....	42
5.2	Bridge 9350	44
5.3	Bridge 27719	46
5.4	Bridge 70037/70038.....	48

5.5	Bridge 27547	49
Chapter 6	Plymouth Avenue Bridge (Bridge ID #27611) in Minneapolis.....	51
6.1	Initial Bridge Inspection Performed by Corven Engineering.....	51
6.1.1	Observations from Investigation by Corven Engineering (2010 report)	52
6.2	Invasive Investigation Performed by VStructural	55
6.2.1	Span 1 Eastbound and Westbound Structures	55
6.2.2	Span 2 Eastbound and Westbound Structures	56
6.2.3	Span 3 Eastbound Structure	58
6.2.4	Span 3 Westbound Structure.....	60
6.2.5	Span 4 Eastbound Structure	64
6.2.6	Span 4 Westbound Structure.....	67
6.2.7	Span 5 Eastbound and Westbound Structures	68
6.3	Summary from Plymouth Avenue Inspection	69
Chapter 7	I-35 NB/SB Bridge ID #69818 in Duluth.....	71
7.1	Visual Inspection Performed by the University of Minnesota Duluth.....	74
7.2	Invasive Investigation Performed by VStructural.....	75
7.2.1	Span 1 of Structural Unit 6N in Northbound Structure	76
7.2.2	Span 2 of Structural Unit 6N in Northbound Structure	77
7.3	Summary from Duluth Bridge 69818 N/S Inspection.....	79
Chapter 8	US 10 EB Bridge, ID #02037E/W in Coon Rapids, MN.....	80
8.1	Invasive Investigation on Bridge #02037 E Performed by VStructural.....	80
8.1.1	Exposure of Ducts at Low Points of Tendon Profile	80
8.1.2	Highpoint of Tendon Profile Duct Inspection	84
8.2	Summary from Coon Rapids Bridge 02037 E Inspection.....	88
8.3	Invasive Investigation on Bridge #02037 W Performed by VStructural	88
8.3.1	Span 3 Bridge 02037 W	89
8.3.2	Span 4 Girder 4 Bridge 02037 W	90
8.3.3	Span 4 Girder 5 Bridge 02037 W	93
8.4	Summary from Coon Rapids Bridge 02037 W Inspection	96
Chapter 9	Blatnick I-535 Bridge ID # 9030 in Duluth.....	97
9.1	Visual Inspection.....	97
9.2	Summary and Recommendations.....	99
Chapter 10	US 10 EB on Ramp Bridge ID #02034 in Coon Rapids.....	100
10.1	Visual Investigation Performed by VStructural	100

10.2	Summary and Recommendations	101
Chapter 11	Inspection Guide for Post-Tensioned Bridges	102
11.1	General Evaluation for All PT Members.....	102
11.2	Specifics for Box Girder Superstructure (Internal Inspection of Internal or External Tendons)	102
11.3	Specifics for End Anchors (Girders, Slabs, Caps or Straddle Bents).....	104
Chapter 12	Conclusions and Recommendations	105
12.1	Plymouth Ave (#27611)	105
12.2	I-35 NB/SB (#69818 N/S)	105
12.3	US 10 EB (#02037 E/W)	105
12.4	Invasive Inspection Recommendation.....	105
References	108
Appendix A. Minnesota Post-Tensioned Bridges Built Prior to 2003: Summaries and Inspection Recommendations		

List of Tables

Table 3.1. Minnesota Department of Transportation condition state definitions for prestressed concrete elements (Minnesota Department of Transportation, 2009)	12
Table 4.1. Minnesota post-tensioned bridge summary	18
Table 4.2. MN PT bridges with highest inspection recommendation.....	20
Table 8.1. Chloride concentration of grout samples	82
Table 8.2. Chloride concentration of grout samples	84
Table 12.1. Bridges in order of recommended inspection	107

List of Figures

Figure 1.1. Strands strung through open duct and anchored in place using tapered wedge fittings (Dywidag International, 2011).....	1
Figure 1.2. Representations of typical tendon profile for single (a) and multi-span beams (b) (not to scale).....	2
Figure 1.3. Post tensioned duct (cross section) filled with grout (Schokker and Schupack, 2003)	2
Figure 1.4. Incline grout test with 0.45 water to cement mix	4
Figure 1.5. Incline grout test with thixotropic grout mix.....	4
Figure 2.1. Plan view of tendon slip at deviation saddle (Corven Engineering, 2002)	5
Figure 2.2. Strands corroded at anchor (Corven Engineering, 2002)	6
Figure 2.3. Water staining at expansion joint around anchor where tendon corroded (Corven Engineering, 2002).....	6
Figure 2.4. Tendon at expansion joint where failure occurred (Corven Engineering, 2002)	7
Figure 2.5. Corroded tendons at breached duct (Corven Engineering, 2002)	8
Figure 2.6. Corroded vertical tendons in Sunshine Skyway Bridge piers (Corven Engineering, 2002)	9
Figure 3.1. Ground penetrating radar in box girder	13
Figure 3.2. Drilling into post-tensioning duct.....	13
Figure 3.3. Use of borescope into post-tensioning duct.....	14
Figure 3.4. Re-sealed exposed duct holes	14
Figure 3.5. Re-sealed exposed duct holes with valve	14
Figure 3.6. Exposing post-tensioning duct by cutting web.....	15
Figure 3.7. Exposing post-tensioning strand and grout by cutting duct	15
Figure 3.8. Exposed post-tensioning strand.....	15
Figure 3.9. Patching of examined duct	15
Figure 4.1. Bridge 27611 aerial view (Bing, 2011)	21
Figure 4.2. Bridge 27611 typical cross section view	21
Figure 4.3. Bridge 27611 tendon profile view A	21
Figure 4.4. Bridge 27611 tendon profile view B	21
Figure 4.5. Bridge 27262 aerial view (Bing, 2011)	22
Figure 4.6. Bridge 27262 typical cross section view	23
Figure 4.7. Bridge 27262 tendon profile view	23
Figure 4.8. Bridge 02037 E aerial view (Bing, 2011).....	24
Figure 4.9. Bridge 02037 E typical cross section view.....	24
Figure 4.10. Bridge 02037 E tendon profile view	25
Figure 4.11. Bridge 02037 W aerial view (Bing, 2011)	26
Figure 4.12. Bridge 02037 W typical cross section view	26
Figure 4.13. Bridge 02037 W tendon profile view	27
Figure 4.14. Bridge 9350 aerial view (Bing, 2011)	28
Figure 4.15. Bridge 27719 aerial view (Bing, 2011)	29
Figure 4.16. Bridge 27719 typical cross section view	29
Figure 4.17. Bridge 27719 tendon profile view	29
Figure 4.18. Bridge 69818 N ground view	30
Figure 4.19. Bridge 69818 N cross section view A	30
Figure 4.20. Bridge 69818 N cross section view B	31

Figure 4.21. Bridge 69818 N typical tendon profile view A	31
Figure 4.22. Bridge 69818 N typical tendon profile view B	31
Figure 4.23. Bridge 69818 N typical tendon profile view C	31
Figure 4.24. Bridge 69818 N typical tendon profile view D	31
Figure 4.25. Bridge 69818 N typical tendon profile view E.....	32
Figure 4.26. Bridge 69818 N typical tendon profile view F.....	32
Figure 4.27. Bridge 69818 N typical tendon profile view G	32
Figure 4.28. Bridge 69818 S aerial view (Bing, 2011).....	33
Figure 4.29. Bridge 02034 (Bing, 2011).....	34
Figure 4.30. Bridge 02034 typical cross section view	35
Figure 4.31. Bridge 02034 tendon profile view A	35
Figure 4.32. Bridge 02034 tendon profile view B	35
Figure 4.33. Bridge 9030 aerial view (Bing, 2011)	36
Figure 4.34. Bridge 70037 aerial view (Bing, 2011)	37
Figure 4.35. Bridge 70037 typical cross section view A	37
Figure 4.36. Bridge 70037 typical cross section view B	38
Figure 4.37. Bridge 70037 typical cross section view C	38
Figure 4.38. Bridge 70037 tendon profile view.....	38
Figure 4.39. Bridge 70038 aerial view (Bing, 2011)	39
Figure 4.40. Bridge 27547 aerial view (Bing, 2011)	40
Figure 4.41. Bridge 27547 cross section view	40
Figure 4.42. Bridge 27547 tendon profile view	40
Figure 5.1. Overview of bridge 27262.....	42
Figure 5.2. Access hatch of bridge 27262.....	43
Figure 5.3. Discoloration of abutment	43
Figure 5.4. Honeycombing along bottom of box girder	44
Figure 5.5. Main spans across the Mississippi River.....	45
Figure 5.6. Post-tensioned pier cap.....	45
Figure 5.7. Bridge 27719 overview picture	46
Figure 5.8. Grout splatter beneath access hatch.....	47
Figure 5.9. Cracking along box girder	47
Figure 5.10. Splice region.....	48
Figure 5.11. Moisture staining on exterior girder	48
Figure 5.12. Bridge 27547 spanning across the Minnehaha Creek	49
Figure 5.13. Slab span of bridge 27547	49
Figure 5.14. Spalling at abutment of bridge 27547	50
Figure 6.1. Elevation and cross section view of Plymouth Avenue Bridge (Corven Engineering, 2010).....	51
Figure 6.2. Bottom slab damage east to west view (Corven Engineering, 2010).....	53
Figure 6.3. Drainage system representation (Corven Engineering, 2010).....	53
Figure 6.4. Bottom slab drainage outlet (Corven Engineering, 2010).....	54
Figure 6.5. Exposed post-tensioned tendons view exterior (Corven Engineering, 2010)	54
Figure 6.6. Exposed post-tensioned tendons view from interior of box girder (Corven Engineering, 2010).....	54
Figure 6.7. Span 1 web S1 and web N1 elevation view	55
Figure 6.8. Span 1 web S2 and web N2 elevation view	55

Figure 6.9. Overview photo of drilled hole into span 1 web S2 tendon A	56
Figure 6.10. Borescope picture of drilled hole in web S2 of span 1	56
Figure 6.11. Cracking in span 2 eastbound structure.....	57
Figure 6.12. Span 2 web S1 and web N1 elevation view	57
Figure 6.13. Span 2 web S2 elevation view.....	57
Figure 6.14. Overview photo of drilled hole into span 2 web S2 tendon B.....	58
Figure 6.15. Borescope picture of drilled hole in web S2 of span 2.....	58
Figure 6.16. Span 3 towards web S1 top view bottom slab.....	59
Figure 6.17. Acid soluble chloride content eastbound span 3	59
Figure 6.18. Span 3 towards web N2 top view bottom slab	60
Figure 6.19. Corrosion product under spalling area at mid span	60
Figure 6.20. Chipping cover from corroded area.....	60
Figure 6.21. Corroded rebar and tendon 19	61
Figure 6.22. Acid soluble chloride results westbound span 3.....	61
Figure 6.23. Overall view of opened/chipped area at mid span.....	62
Figure 6.24. Shows tendon 16 with corroded duct	62
Figure 6.25. Opened tendon 16 with green corrosion product	63
Figure 6.26. Tendon B15 with removed window exposing multiple strands	63
Figure 6.27. Crack along anchorage of tendon B28/B24.....	64
Figure 6.28. Crack along length of box girder.....	64
Figure 6.29. Span 4 towards web S2 top view bottom slab.....	64
Figure 6.30. Acid soluble chloride test results eastbound span 4	65
Figure 6.31. Removal of concrete exposing tendon B28.....	65
Figure 6.32. Corrosion on tendon B28.....	66
Figure 6.33. Web S1 eastbound structure span 4 drill locations.....	66
Figure 6.34. Drainage duct with moisture staining.....	67
Figure 6.35. Web S2 eastbound structure span 4 drill locations.....	67
Figure 6.36. Cracking along anchorage blister in span 4.....	68
Figure 6.37. Web N1 westbound structure span 4 drill locations.....	68
Figure 6.38. Web N2 westbound structure span 4 drill locations.....	68
Figure 6.39. Span 5 web S1 and web N1 elevation view	69
Figure 6.40. Span 5 web S2 and web N2 elevation view	69
Figure 7.1. Pier 1N/1S to 3N/1S aerial view with corresponding design drawing (Bing, 2011) .	71
Figure 7.2. Pier 3N/2S to 6N/5S aerial view with corresponding design drawing (Bing, 2011) .	72
Figure 7.3. Pier 6N/5S to 10N/8S aerial view with corresponding design drawing (Bing, 2011)	72
Figure 7.4. Pier 10N/8S to 14N/12S aerial view with corresponding design drawing (Bing, 2011)	73
Figure 7.5. Pier 15N/13S to 23N/21S aerial view with corresponding design drawing (Bing, 2011)	73
Figure 7.6. Pier 23N/21S to 30N/28S aerial view with corresponding design drawing (Bing, 2011)	74
Figure 7.7. Cracking at connection of structural units.....	74
Figure 7.8. Diagonal cracking on interior of box girder.....	75
Figure 7.9. Access hatch for structural unit 6N	75
Figure 7.10. Plan view of structural unit 6N.....	76
Figure 7.11. Span 1 web 2 structural unit 6N tendon profile view	76

Figure 7.12. Tendon 2 view with borescope.....	77
Figure 7.13. Span 1 web 3 structural unit 6N tendon profile view.....	77
Figure 7.14. Span 2 web 2 structural unit 6N tendon profile view.....	78
Figure 7.15. Span 2 web 3 structural unit 6N tendon profile view.....	78
Figure 7.16. Span 2 web 4 structural unit 6N tendon profile view.....	78
Figure 7.17. Span 2 web 5 structural unit 6N tendon profile view.....	79
Figure 8.1. Plan view of span 1 and 2.....	81
Figure 8.2. Discolored patchwork at mid span (Span 2).....	81
Figure 8.3. Cut out area exposing ducts.....	82
Figure 8.4. Opened tendon 2.....	82
Figure 8.5. Removing cover at inspection area.....	83
Figure 8.6. Exposed ducts in girder 5 of span 2.....	83
Figure 8.7. Bleed trail in tendon 2.....	84
Figure 8.8. Span 2 tendon profile of girder 5.....	85
Figure 8.9. Borescope picture of drilled hole in girder 5 of span 2.....	85
Figure 8.10. Borescope picture looking toward highpoint in tendon 1.....	86
Figure 8.11. Borescope picture looking toward low point in tendon 1.....	86
Figure 8.12. Borescope picture looking toward highpoint in tendon 2.....	87
Figure 8.13. Borescope picture looking toward low point in tendon 2.....	87
Figure 8.14. Borescope picture looking toward highpoint in tendon 3.....	88
Figure 8.15. Borescope picture looking toward low point in tendon 3.....	88
Figure 8.16. Span 3 tendon profile of girder 5.....	89
Figure 8.17. Borescope picture of drilled hole in girder 5 of span 3.....	89
Figure 8.18. Span 4 tendon profile of girder 4.....	90
Figure 8.19. Borescope picture of drilled hole in girder 4 of span 4.....	91
Figure 8.20. Borescope picture looking toward highpoint in tendon 3, 6 inches (15.2 centimeters) inside of the inspection hole.....	91
Figure 8.21. Borescope picture looking toward highpoint in tendon 3, 24 inches (61 centimeters) inside of the inspection hole.....	92
Figure 8.22. Borescope picture looking toward highpoint in tendon 3, 3.5 feet (1.07 meters) inside of the inspection hole.....	92
Figure 8.23. Borescope picture looking toward low point in tendon 3, 6 inches (15.2 centimeters) inside of the inspection hole.....	93
Figure 8.24. Span 4 tendon profile of girder 5.....	93
Figure 8.25. Borescope picture of drilled hole in girder 5 of span 4.....	94
Figure 8.26. Borescope picture looking toward highpoint in tendon 3, 6 inches (15.2 centimeters) inside of the inspection hole.....	95
Figure 8.27. Borescope picture looking toward highpoint in tendon 3, 18 inches (45.7 centimeters) inside of the inspection hole.....	95
Figure 8.28. Borescope picture looking toward highpoint in tendon 3, 5.5 feet (1.68 meters) inside of the inspection hole.....	96
Figure 8.29. Borescope picture looking toward low point in tendon 3, 46 inches (116.8 centimeters) inside of the inspection hole.....	96
Figure 9.1. PT cap on Blatnick Bridge pier.....	97
Figure 9.2. Cracking extending from anchorage on PT pier cap.....	98
Figure 9.3. Vertical and horizontal cracking in pier.....	98

Figure 9.4. Longitudinal view of typical post-tensioned pier	99
Figure 10.1. Pier with cracking and efflorescence.....	100
Figure 10.2. Cracking along straddle bent	101

Executive Summary

Post-tensioned (PT) concrete bridges can be very durable if properly constructed with high performance materials. Problems were found in grouted post-tensioned ducts in Florida during the late 1990s and early 2000s that indicated a change in grouting materials and construction practices were necessary. Since that time, materials and practices have been significantly improved. States that have investigated older PT bridges have found widely varying levels of deterioration depending on climate, construction practices, structure type and other variables. In the case of bridges built prior to around 2003, voided areas in the grouted tendons are fairly common.

This report focuses on PT bridges built in Minnesota prior to 2003. The scope is limited to providing a targeted check of bridges that are most likely to have grouting related corrosion problems based on a review of plans and inspection notes. The project consisted of three phases: 1) review of plans and inspection reports of 40 post-tensioned bridges constructed prior to 2003; 2) selection of 10 bridges for a limited onsite inspection of the exterior of the bridge; 3) invasive inspection of 3 select bridges. The bridges selected were chosen to represent different bridge construction types to provide a spot check of the PT bridge inventory in Minnesota. One of the three bridges has corrosion and voids due to poor grouting, one has a major corrosion problem related to construction issues (but appears to have good grout), and one showed no tendon corrosion or grouting problems during the invasive spot checks.

Recommendations are given at the end of the report specific to the bridges that were investigated as well as for a general inspection plan for post-tensioned bridges in Minnesota. A concise guide for bridge inspection staff is provided that is specific to post-tensioned bridges.

Chapter 1 Background

1.1 Post-Tensioning Basics

Driven by material shortages during World War II in the 1930's, Europe began the movement towards the development of prestressed concrete (Nilson, 1987). Post tensioning is a method of prestressing concrete by applying the tensioning force after the concrete has hardened. It is used in many applications including in bridges and buildings. By applying an active force on the concrete member, post-tensioning can put the concrete into a pre-compressive state to overcome applied tensile forces. The process is done by using a hollow metal or plastic duct or conduit within the concrete beam or girder. High strength steel in the form of a bar or strand (typically multiple wires strung together) are strung through the duct (typically in multi-wire bundles for bridge applications) and as a unit are considered a tendon. Once the beam or girder has cured to a sufficient strength to support the compressive force, tension can be applied to the strands/tendon. Using the beam or girder to react against, a permanent tapered wedge system holds the individual strand (a separate tapered wedge for each strand running through the duct into the anchor unit) as a hydraulic jack is used to apply tension to the live end of the tendon. Once proper tension is achieved in each of the strands in the tendon, the live end is anchored in place using tapered wedge fittings.

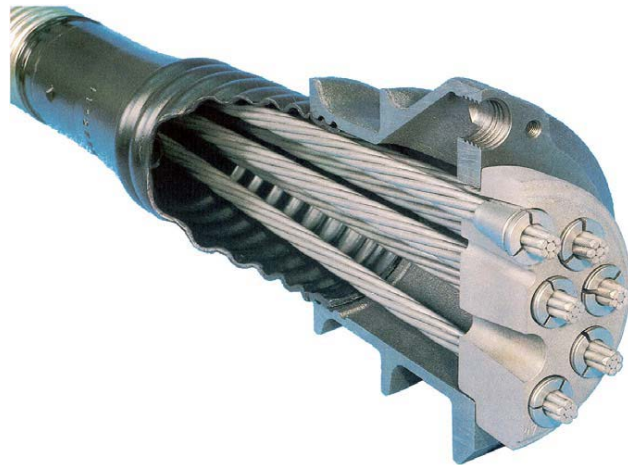

Figure 1.1. Strands strung through open duct and anchored in place using tapered wedge fittings (Dywidag International, 2011).

Figure 1.2 shows a typical tendon profile for a single span, simply supported box girder (a), and a multiple span open box girder (b), where the varying profile accommodates for alternating negative and positive moment.

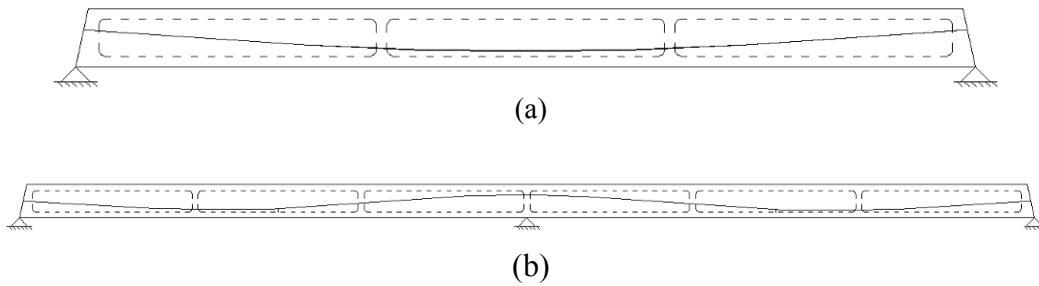

Figure 1.2. Representations of typical tendon profile for single (a) and multi-span beams (b) (not to scale)

There are a range of benefits that post-tensioning can provide for structural, construction and durability benefits. However, the steel strand or bars are susceptible to corrosive elements and must be protected. Several levels of corrosion protection may be used, including road surface treatments, plastic duct, and high performance grout. The grout provides bond as well as corrosion protection for the strand. The strands themselves can also have a protective coating such as epoxy or galvanizing, but this is not typically used. Figure 1.3 shows a cross section of duct containing multiple strands that has been filled with grout. The strands are all clustered on one side of the duct due to stressing in a varying tendon profile.



Figure 1.3. Post tensioned duct (cross section) filled with grout (Schokker and Schupack, 2003)

The use of post-tensioning has substantial potential structural benefits. Because the structure is relieved of all (or nearly all) tension at service load levels, the structure remains essentially uncracked. If overload occurs, the active post-tensioning force also is able to close the cracks after the load is removed. When used in structural elements, reductions in element (girder, slab, etc) size and quantity are made possible compared to traditional reinforcement methods. This

efficiency results in a smaller quantity of concrete, thus lower dead load and resulting reduction of supporting elements such as piers and foundations. The reduction in concrete quantity also reduces the greenhouse gas emissions associated with the structure due to the reduction in cement. Supplementary cementitious materials such as fly ash, silica fume, or slag cement can further reduce greenhouse gas contributions.

1.2 Post-Tensioning Grout

Properly constructed post-tensioned bridges can be very durable due to the reduced cracking and multiple levels of protection for the prestressing steel. As the last level of defense for the strand against corrosion, the cementitious grout plays an important role in the long-term durability of the structure. The strand in the tendon needs to be contained in the high pH grout to have protection against corrosion. Voids in the duct can leave the strand vulnerable to corrosion, particularly in the presence of oxygen and moisture. Chlorides in high enough concentrations can break down the protection passive film formed on the steel in the high pH environment of grout or concrete. A breach in the passive film exposes the strand to pitting corrosion that is a form of localized attack. A fully grouted, sealed tendon that has proper anchorage protection is needed for the best possible protection.

Grout serves as the last line of defense against corrosion for the post-tensioning strands. Inadequate grout protection for the strand (voids within the duct) occurs primarily from improper filling of the duct, or from bleed occurring from the grout (absorption of bleed water). Issues that impede the complete filling of the duct can occur from sources such as improper ventilation resulting in trapped air pockets within the duct, clogging of the duct, or poor workmanship during the time of construction. Bleed occurs from the grout when a segregation of the cement and water occurs while the grout is in its plastic state. This occurrence is magnified when the tendon profile undergoes a change in elevation which results in hydrostatic pressure forcing the separation of the water and cement to take place (Schokker, Hamilton and Schupack, 2002). Another contribution to the quantity of bleed in a system is the wicking effect that is created from the strands. The multi-wire strands act as a filter for the water to separate from the cement, and create a bleed channel for the water to travel from the dense low areas to the high points in the tendon (buoyancy effect). The resulting void in the tendon provides a space for oxygen, moisture and contaminants (such as chlorides from road salt or from proximity to the ocean) to collect and lead to corrosion of the strand.

Bridges built prior to 2003 are likely to have been built with grout that is susceptible to having bleed issues (and are the focus of the report). Bridges built after 2003 in Minnesota typically have a pre-packaged thixotropic grout that minimizes the effect of bleed in the system. The thixotropic grout is fluid when freshly mixed, but enters a gel-like state when left stagnant. Figure 1.4 and 1.5 show the difference between a thixotropic grout and standard water-cement ratio grout with only a single 7-wire strand with a vertical rise of 8' (2.4 m). The picture was taken approximately 10 minutes after grouting and the plain grout already has significant bleed. The thixotropic grout exhibited no visible bleed in this test. Problems resulting from bleed in grout are detailed in the case studies in Chapter 2.



Figure 1.4. Incline grout test with 0.45 water to cement mix

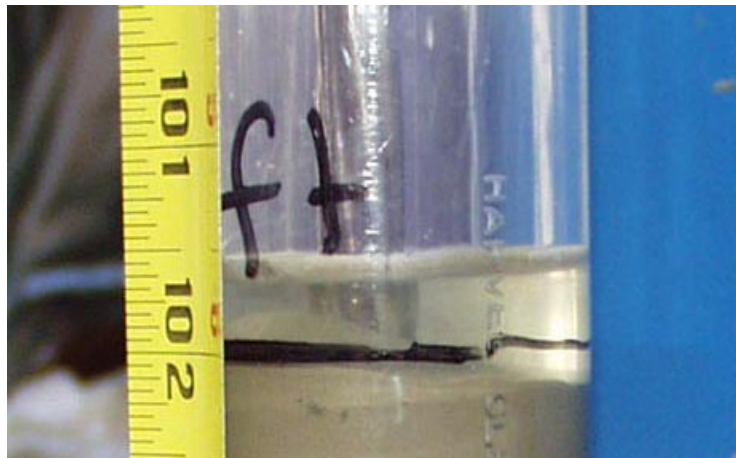

Figure 1.5. Incline grout test with thixotropic grout mix

Chapter 2 Literature Review

2.1 Case Studies of Grouting Related Problems

Proper construction practice as well as preventive maintenance is important for maintaining bridge structural integrity for its intended service life. Inspections must be performed to monitor potential problems, and to be able to remediate these problems before they lead to a deficient structure. In post-tensioned structures, visual indicators may be limited since corrosion can occur inside the duct without showing major external cracking or rust staining until the tendon is fully compromised. Several case studies are presented in this section as a review of problems in the United States in grouted post-tensioned bridges that began surfacing in 1999. Problems had occurred in Europe approximately a decade before, but the focus here is on U.S. structures since construction and design practices tend to differ slightly in the US compared to in other countries.

2.1.1 *The Niles Channel Bridge*

Located in the Florida Keys, the Niles Channel Bridge built in 1983 is a 4,557 foot long bridge (4557 m) with a deck width of 38.5 feet (11.7 m). It spans between Summerland Key and Ramrod Key over salt water. The bridge was built with precast box girders with six grouted external post tensioned tendons in each span. During an inspection in the summer of 1999, several notable problems were recorded. The first critical problem found was that one of the exterior tendons had slipped at the deviation saddle approximately 9 inches (22.9 cm), indicating a tendon failure (see figure 2.1).



Figure 2.1. Plan view of tendon slip at deviation saddle (Corven Engineering, 2002)

After full inspection, it was found that one of the six tendons in each span had failed. The boot connecting the steel pipe and the duct was opened for further investigation and active corrosion was found. Investigation of the removed tendon showed voids in the grout around the tendon, and pitting on the prestressing strands at the anchor head as shown in figure 2.2. The failed tendons were removed and replaced.



Figure 2.2. Strands corroded at anchor (Corven Engineering, 2002)

There was initial concern that this corrosion at the voids was due to corrosive bleed water from the grout, although continued examination concluded that the corrosion was due to saltwater ocean spray. It was believed that the wind carried ocean spray and came into contact with the tendons through a void in the anchor head. Seeping between the segments at the expansion joints the chloride enriched water entered the anchor and provided the conditions for active corrosion to occur. Figure 2.3 shows the staining around the anchor where the tendon corroded. While the bleed water itself did not corrode the strands, the void left by the bleed water provided a void where chlorides, moisture and oxygen could congregate and cause severe corrosion.



Figure 2.3. Water staining at expansion joint around anchor where tendon corroded (Corven Engineering, 2002)

2.1.2 The Mid-Bay Bridge

The Mid-Bay Bridge spans 3.6 miles (19,265 feet or 5872 meters) across Choctawhatchee Bay between Destin and Niceville, Florida. The bridge is built with segmental precast concrete box girders. Six tendons span eight to nine segments, with nineteen strands in each 4 in (10.2 cm) polyethylene ducts (Hartt and Venugopalan 2002). During an inspection of the bridge on August

28, 2000 it was discovered that two tendons had failed. One of the failures was similar to that seen in the Niles Channel Bridge with corrosion concentrated at the anchor head. Figure 2.4 shows the tendon pullout at the expansion joint.



Figure 2.4. Tendon at expansion joint were failure occurred (Corven Engineering, 2002)

The second tendon that had failed was due to a breach in the duct that allowed ingress of moisture and oxygen. Further examination of breached ducts was performed, and a correspondence was found between the occurrence of cracked ducts, and voids in the grout (Hartt and Venugopalan 2002). Figure 2.5 shows the failed tendon in the free length of the duct. The duct cracking was the result of the use of a brittle duct material that met the required specification, but that was inappropriate for post-tensioning. Additional requirements have now been added for post-tensioning duct material (Post-Tensioning Institute, 2003).



Figure 2.5. Corroded tendons at breached duct (Corven Engineering, 2002)

Due to the failures found after the initial inspection, an in depth investigation was performed on all ducts. Using several different testing methods it was found that eleven tendons were found to be corroded and required replacement; two additional tendons were found to have corrosion, but did not warrant replacement (Hartt and Venugopalan 2002).

2.1.3 The Sunshine Skyway Bridge

The Sunshine Skyway Bridge connects St. Petersburg and Terra Ceia over Tampa Bay in Florida. The original bridge was built in 1954 and was the first post-tensioned bridge in Florida. Corrosion was observed in the box girders due to insufficient concrete cover at the end anchor blocks, which in turn subjected the tendons to corrosive elements such as saltwater (Corven Engineering, 2002). A replacement bridge was built in 1987 that spans 5.5 miles (29,040 feet or 8851 meters) across the Tampa Bay. This precast bridge consists of both internal and external tendons. During an inspection of the bridge on September 21, 2000, the Florida Department of Transportation found severe corrosion in the vertical looped tendons in a high-level approach pier. The tendon had severe corrosion damage with breaks in 11 of the 17 strands as seen in figure 2.6.



Figure 2.6. Corroded vertical tendons in Sunshine Skyway Bridge piers (Corven Engineering, 2002)

2.2 Current Status

The findings in these bridges led to inspection of post-tensioned bridges across the United States and in implementation of improved grouting materials and procedures. The Post-Tensioning Institute (PTI) released the Specification for Grouting of Post-Tensioned Structures (Post-Tensioning Institute, 2003) and the American Segmental Bridge Institute developed a Grouting Certification program that has been held yearly since 2001 (first held August 6-8, 2001). The PTI specification has continued to update the grouting specification as the state-of-the-art progresses.

Implementation of specifications, training, and the development of prepackaged anti-bleed grouts has significantly lessened the potential for grouting related problems. Problems can still occur if design, construction, and grouting materials are not all adequately considered, but the improvement in performance between grouts used prior to 2000 and today's grouts is dramatic. This report is focused on Minnesota post-tensioned bridges constructed prior to 2003 to include bridges that were likely to have been grouted under the old practices and materials. The next chapter details the inspections done for this study.

Chapter 3 Inspection and Testing

Visual inspection of post-tensioned (PT) bridges shares some of the basic procedures of non-PT concrete bridges. Cracking, spalling, and staining all provide clues to the condition of the bridge and potential general problem areas. However, the PT tendons themselves will typically provide very little external visual indication of problems prior to failure or significant loss of prestress in the tendon.

Due to the complexity of grouted post-tensioning tendons, the authors feel that traditional non-destructive inspection methods have not proven to be reliable and robust for field investigation of PT bridges. Methods such as impact-echo can contribute to finding problem areas for specific cases, but have limitations for plastic duct. All of the non-destructive methods also require a combination of techniques including follow-up with destructive evaluation for reliable results. An extensive study by the Florida DOT evaluating multiple methods on an actual structure supports this determination (DMJM Harris, 2003).

One minimally invasive method that has been used successfully for investigating potential voids in the tendon anchor area is investigation by borescope. If accessible, the pourback or other anchor pocket protection is removed to investigate the condition of the anchor head, strand tails, and wedges. The grout port is then typically used for borescope access if possible. If the grout port has a 90° angle (typical of older construction), a separate access point may need to be drilled into the trumpet area (avoiding drilling through the anchor/bearing plate). Due to the demand from the DOTs, the PT hardware manufacturers now have anchorage hardware to accommodate the easy insertion of a borescope. An anchorage area may contain a void, but still have a fully grouted inlet portion, so the grout is removed in the access port to reach the potentially voided area. The borescope can also be used along the length of the tendon by drilling access points. Florida DOT has a large series of reports (10 volumes) fully documenting their investigation procedures, including use of a borescope in the inspection (FDOT, 2004).

The most variable part of an inspection of a PT tendon is isolating the potential problem areas for focused inspection. Anchorages and high points are typically key areas due to the potential presence of grout bleed water (Bricker & Schokker, 2004), but each bridge has specifics that will lead to variations in target areas. Review of plans and construction documents are very valuable in identifying key areas prior to the on-site investigation.

This chapter describes the various levels of inspection used in the project.

3.1 MnDOT Current Bridge Inspection Procedures

Routine inspections are performed by city, state, and county personnel on an annual basis to check the integrity of structures in Minnesota, and make note of any change in conditions that occur between inspection dates. The department that is responsible for a particular bridge inspection is dependent on who owns the particular bridge and what facility/feature it has. In Minnesota any agency conducting an inspection on a bridge must have a Bridge Inspection Program Administrator who is a registered Professional Engineer (PE), and who must regularly attend MnDOT Bridge Inspection seminars. The duties of the Bridge Inspection Program

Administrators are to review inspection reports and structure inventory reports and decide if action needs to be taken (Minnesota Department of Transportation, 2009).

An overall bridge condition rating is assigned to a bridge based on the National Bridge Inventory (NBI) rating, and a sufficiency rating that is calculated using a system developed by the Federal Highway Administration (FHWA). The NBI rating is used to describe the general overall condition of three bridge elements: the deck, the superstructure, and the substructure. The sufficiency rating (ranging from 0 to 100) is assigned by using a formula based on structural condition, bridge geometry, and traffic considerations (Federal Highway Administration, 1995). The sufficiency rating is used to determine the eligibility to receive federal funding for a particular bridge. When a bridge receives a rating of 80 or less it becomes eligible for federal bridge rehabilitation funding, and when it receives a rating of 50 or less it becomes eligible for federal bridge replacement funding (Federal Highway Administration, 1995).

Pontis is a software program used to manage the bridge inventory data. Pontis elements of the bridge are divided into five groups which are dependent on the structural function they serve. These categories include deck elements, superstructure elements, substructure elements, culvert elements and miscellaneous elements. These 5 elements are further divided into material groupings that include painted steel, unpainted weathering steel, reinforced concrete, prestressed (or post-tensioned) concrete, timber, masonry, other materials, and combinations of materials. These Pontis elements receive a rating that is unique depending on the category (Minnesota Department of Transportation, 2009).

Currently inspections done on prestressed concrete elements are done using a condition state scale. The inspector is checking primarily for cracks (which lead to water and chlorides that may corrode steel reinforcement) and rust stains that indicate actual corrosion. A condition state scale from 1 to 4 is used where 1 indicates little or no deterioration and 4 indicates severe deterioration. The rating is based on the inspector's discretion to the condition of the element (Minnesota Department of Transportation, 2009). Table 3.1 shows the index description of the condition state.

Table 3.1. Minnesota Department of Transportation condition state definitions for prestressed concrete elements (Minnesota Department of Transportation, 2009)

Condition State 1	Pre-stressed concrete element has little or no deterioration. There is no notable cracking, staining, delamination or spalling. The member has no impact damage or repair patches.
Condition State 2	Pre-stressed concrete element has minor deterioration. There may be minor (non-structural) cracking, leaching, staining, or surface scale. There is no structural cracking (from shear or flexure). Minor delaminations or spalls may be present, but there is no exposure of the tensioning steel. Element is in proper position and alignment - all connections are sound. Repair patches (if any) remain sound. Note: elements that have been repaired or reinforced should generally not be rated above Condition 2.
Condition State 3	Pre-stressed concrete element has moderate deterioration, but the load-carrying capacity of the element has not been significantly reduced. There may be moderate cracking, leaching, staining, or scale. Structural cracking (from shear or flexure) may be present. Delaminations and spalls may be present. While the tensioning steel may be exposed, any section loss is incidental and does not significantly affect the strength and/or serviceability of either the element or the bridge. Element may be slightly out of position or alignment - connections may have started to come loose.
Condition State 4	Pre-stressed concrete element has severe or critical deterioration. The load-carrying capacity of the element has been significantly reduced - structural analysis or immediate repairs may be required. Severe structural cracking (from shear or flexure) may be present. Spalling may be extensive or severe - exposed tensioning steel may have significant section loss. The element may be severely damaged or significantly out of position or alignment - connections may have failed.

Within the Minnesota Department of Transportation inspection procedure smart flags are used to identify specific problems that occur (i.e. cracking, spalling, rust staining, etc.). These flags are used to indicate special attention or follow up action that may be needed, or give specific conditions of elements. Within a smart flag a condition state is designated to give approximate extent of problem. Condition is assigned at the discretion of inspector with no quantitative categorizing. No smart flags are currently used that are specific to post-tensioned elements (Minnesota Department of Transportation, 2009).

3.2 Invasive Investigation Performed by VStructural

VStructural, a company with extensive experience in evaluating post-tensioned structures, performed all invasive inspection in this project. The VStructural team was led by Bruce Osborn, who has extensive experience in PT bridge inspection. All post-tensioned tendons evaluated were internal tendons, so ground penetrating radar (GPR) was used to limit the number of holes drilled in the structure to access the grouted tendons. This operation was performed by Universal Construction Testing (UCT) during the December inspections in bridge 27611 in Minneapolis (Plymouth Avenue Bridge), and by Wiss, Janney Elstner Associates (WJE) during the August inspection of bridge 69818 in Duluth and bridge 02037 in Coon Rapids. Once the tendons were mapped, a hole was drilled to reach the duct, grout and strand.

Using ground penetrating radar (GPR), the parabolic shape of the tendon could be mapped from the interior of the box girder segments. Figure 3.1 shows GPR mapping in progress.



Figure 3.1. Ground penetrating radar in box girder

After the mapping was completed, select locations were drilled at varying depths to penetrate the duct. Figure 3.2 shows VStructural personal drilling into the internal post-tensioning duct in an interior web of the box girder at a tendon high point near a pier. The true high point typically cannot be reached due to the heavy reinforcement congestion as the tendon enters the end block or diaphragm, but inspection of areas near the high point are valuable indicators of potential voids or corrosion.



Figure 3.2. Drilling into post-tensioning duct

Once the duct had been breached, a visual inspection of the grout, the post-tensioning strand, and the interior of the duct (in the case of a void) was performed with the use of a borescope. Pictures are taken with the borescope of the condition inside the duct. Figure 3.3 shows the borescope being used to evaluate a tendon.



Figure 3.3. Use of borescope into post-tensioning duct

Once the duct inspection was completed and samples had been taken, the drilled holes were filled with Hilti HY150 Epoxy to insure the tendons would not experience additional exposure due to the invasive inspection. This Hilti fill material is a fast set, high strength non-shrink epoxy that was designed for anchor embedment. Seen in figure 3.4 is the filing of the hole with the Hilti HY 150 Epoxy. When a void was found in the duct, a valve was sealed into the created hole to allow for the duct to be filled during future repair. The valve is capped and sealed to ensure no additional ingress of moisture or oxygen prior to repair. Figure 3.5 shows the embedded valves placed after inspection.



Figure 3.4. (Left) Re-sealed exposed duct holes

Figure 3.5. (Right) Re-sealed exposed duct holes with valve

When visual signs pointed to a larger potential problem area (moisture, rust staining, cracking), a section of the web was removed to expose a length of the duct. Removal of the web concrete cover is shown in figure 3.6. This removal reveals a section of duct so that its condition can be evaluated. A window is then cut into the duct (shown in figure 3.7) to allow inspection of the grout and strand condition.



Figure 3.6. (Left) Exposing post-tensioning duct by cutting web

Figure 3.7. (Right) Exposing post-tensioning strand and grout by cutting duct

Once the duct has been opened, the surrounding grout is examined and samples are taken. After the duct is opened, all additional excavation is done by hand without power tools so that the strand is not accidentally nicked. The condition of the post-tensioned strands is also inspected at this point. Strand condition was evaluated for degree of corrosion in relation to a ranking from Sason (1992) as published by PCI. After the inspection of the post-tensioning system is completed, the window of the duct that was removed could be re-bonded with the Hilti HY 150 Epoxy, and a Sika 123 repair patch was used to cover the exposed area. Figure 3.8 and figure 3.9 show the exposed strand in the tendon, and the patching procedure on the duct, respectively.



Figure 3.8. (Left) Exposed post-tensioning strand

Figure 3.9. (Right) Patching of examined duct

3.3 Acid Soluble Chloride Testing

Samples of concrete and grout can be taken to determine acid-soluble chloride content. Samples were analyzed at the University of Minnesota Duluth following the American Association of State Highway and Transportation Officials (AASHTO) specification T-260 “Standard Method for Sampling and Testing for Chloride Ion in Concrete and Concrete Raw Materials.” The test provides a method to measure the acid-soluble chlorides (which in most cases is roughly equivalent to the total chloride content) measured as a percent weight of the concrete. A rotary impact drill is used to obtain a powdered sample, and if necessary, a mortar and pestle is used to

insure the required particle size was obtained. The obtained sample was dissolved in an extraction liquid consisting of a precise concentration of acid. Within the acid solution, the chloride ions (if any are contained in the concrete) react with the acid to create an electrochemical reaction and the chloride electrode is then used to determine the chloride content.

Chapter 4 Evaluation of Post-Tensioned Bridge Inventory

Over 40 post-tensioned bridges were constructed construction prior to 2003 as listed in the MnDOT inventory. Each of these bridges was in service at the start of this project. The Plymouth Avenue Bridge (owned by the City of Minneapolis) is now closed until repairs can be made. These bridges include those classified as box girders, deck girders, slab spans and beam span sections. Table 4.1 lists each bridge (by MnDOT Bridge ID number listing) in order of bridge type and then by year built (oldest to youngest). Included information in the table is the year the bridge was built, the length, number of spans and the deck width. Also included is the NBI rating, and sufficiency rating that was assigned by city, state, and county personal during the annual bridge inspection last performed. The NBI rating shown in table 4.1 has three values listed which represent the deck, superstructure, and substructure grade received respectively. The sufficiency rating is assigned by using a formula based on structural condition, bridge geometry, and traffic considerations (Federal Highway Administration, 1995). The last column includes the inspection recommendation (IR).

Table 4.1. Minnesota post-tensioned bridge summary

Bridge ID Number	Span Type	Year Built	Sufficiency Rating	NBI Rating	Total Length in Feet (Meters)	Deck Width in Feet (Meters)	IR
27581	BOX GIRDER	1974	97.2	7.7.8	86 (26.2)	58.70 (17.9)	5
27593	BOX GIRDER	1974	79.4	7.7.8	126 (38.4)	70.00 (21.3)	7
27611	BOX GIRDER	1980	81.0	7.7.8	944 (287.7)	77.00 (23.5)	10
27622	BOX GIRDER	1980	78.6	7.8.8	104 (31.7)	38.20 (11.6)	4
27717	BOX GIRDER	1980	85.0	7.7.7	77 (23.5)	156.30 (47.6)	4
27904	BOX GIRDER	1980	99.0	7.7.7	98 (29.9)	27.60 (8.4)	4
27623	BOX GIRDER	1980	78.6	7.8.8	104 (31.7)	38.20 (11.6)	4
27719	BOX GIRDER	1982	80.5	7.8.8	93 (28.3)	70.30 (21.4)	8
27810	BOX GIRDER	1982	85.0	7.7.7	74 (22.6)	152.30 (46.4)	4
69818N	BOX GIRDER	1985	93.5	7.7.8	2,736 (833.9)	42.40 (12.9)	8
69818S	BOX GIRDER	1985	93.5	7.7.8	2,732 (832.7)	42.40 (12.9)	8
02034	BOX GIRDER	1996	93.4	7.8.7	407 (124)	55.77 (17)	8
62555A	BOX GIRDER	1996	97.5	8.8.8	1,253 (382)	47.70 (14.5)	6
62555B	BOX GIRDER	1996	97.5	8.8.8	1,253 (382)	47.70 (14.5)	6
02037E	BOX GIRDER	1997	97.6	7.8.7	479 (146)	49.21 (15)	9
02037W	BOX GIRDER	1997	94.5	7.8.7	597 (182)	49.21 (15)	9
02044	BOX GIRDER	1997	NA	7.7.7	262 (80)	13.12 (4)	5
27194	BOX GIRDER	1998	98.2	7.7.7	690 (210.3)	45.30 (13.8)	8
27217	BOX GIRDER	1998	99.3	7.7.7	550 (167.6)	33.10 (10.1)	8
27218	BOX GIRDER	1998	97.1	7.8.8	568 (173.1)	46.60 (14.2)	6
27219	BOX GIRDER	1998	97.1	7.8.8	545 (166)	46.50 (14.2)	6
27220	BOX GIRDER	1998	NA	7.8.8	694 (211.4)	11.40 (3.5)	6

27262	BOX GIRDER	2002	NA	8.8.8	2,072 (631.7)	49.00 (14.9)	10
82856	BOX GIRDER	2003	82.0	8.8.8	1,892 (576.6)	98.70 (30.1)	7
82855	BOX GIRDER	2003	84.0	9.9.9	1,892 (576.6)	85.90 (26.2)	3
27264	BOX GIRDER	2003	NA	8.8.8	1,342 (408.9)	28.00 (8.5)	7
95893A	DECK GIRDER	1986	NA	B.B.B	336 (102.4)	130.00 (39.6)	3
27547	SLAB SPAN	1970	91.1	7.7.8	53 (16.2)	67.00 (20.4)	4
52009	SLAB SPAN	1985	90.8	7.7.7	145 (44.1)	106.30 (32.4)	7
94174	SLAB SPAN	1989	NA	6.7.7	266 (80.9)	110.00 (33.5)	4
20004	SLAB SPAN	1996	90.7	7.7.7	178 (54.3)	52.80 (16.1)	3
27A32	SLAB SPAN	1997	97.4	8.8.8	197 (60.2)	58.50 (16.1)	3
27192	SLAB SPAN	2000	79.0	8.8.8	112 (34)	49.70 (15.1)	2
54544	SLAB SPAN	2000	93.0	8.8.8	183 (55.6)	32.00 (9.8)	2
27A58	SLAB SPAN	2000	92.2	8.8.8	261 (79.4)	44.20 (13.5)	5
70037	BEAM SPAN	1994	93.8	7.7.7	180 (54.7)	44.20 (13.5)	7
70038	BEAM SPAN	1994	93.8	7.7.7	180 (54.7)	46.50 (14.2)	7
9030	PT Pier Cap	1992	53.8	6.5.6.7	7,980 (2,432.3)	63.7 (19.4) (varies)	8
9350	BEAM SPAN	1994	85.5	7.6.7.7	1,001 (305.1)	141.30 (43.1) (varies)	9

To narrow down the investigation to a select number of bridges, a rating was assigned to each bridge based on inspection notes, tendon configuration including tendon size and vertical rise, and any unusual factors that make the bridge of interest with respect to post-tensioning specifics. A rating was given to each bridge by the project team on a scale of 1-10 with 10 being the highest recommendation for inspection under this contract. Appendix A provides the summary for each of the 40 bridges based on initial review of plans and inspection notes including the basis for the ratings given. Table 4.2 shows the ten bridges that received the highest recommendation for inspection. The table includes the bridge ID number, the facility that the bridge services, the type of bridge span type, the year the bridge was built and the inspection recommendation. The bridges in bold font were chosen for a more in depth visual inspection based on initial visual inspection and the recommendation rating. Of these 5 bridges, 3 then had invasive inspections (those shown in bold italics).

Table 4.2. MN PT bridges with highest inspection recommendation

Bridge ID Number	Facility	Bridge Type	Year Built	Inspection Recommendation
27611	Plymouth Ave	Box Girder	1980	10
27262	LRT	Box Girder	2002	10
02037 E/W	US 10 EB	Box Girder	1997	9
9350	I-94	PT Cap	1994	9
27719	Lyndale Ave N	Box Girder	1982	8
69818 N/S	I 35 NB/SB	Box Girder	1985	8
02034	US 10 EB On Ramp	Box Girder	1996	8
9030	Blatnick (I-535)	PT Cap	1992	8
70037/70038	US 169 EB/WB	Spliced Girder	1994	7
27547	Chicago Ave S	Slab Span	1970	4

The slab span was chosen for visual inspection due to its age and as a representative of this type of post-tensioned structure. The spliced girder bridge was chosen as the only representative of this type of structure in the database (prior to 2003). The two PT cap structures each were a retrofit/repair case and both had indications of potential problems from the inspection notes. The remaining bridges chosen were the top ranking box girder bridges based on the inspection notes.

4.1 Summary of Bridges Selected for Visual Inspections

The initial summary notes for the ten bridges that were chosen for external visual inspection (as seen in table 4.2) are given in this section (in descending order of recommendation for inspection rating). Each bridge summary includes a summary table, representative figures (aerial view, and design drawings), inspection notes that are applicable to post-tensioning system condition, and a discussion of the bridge characteristics in relation to the post-tensioning system. The bridges are in descending order of their assigned inspection recommendation rating.

4.1.1 Bridge 27611

District:	Metro	City:	Minneapolis
Year built:	1980	Bridge Type:	PT box girder
Facility:	Plymouth Ave	Feature:	Mississippi River
Length:	944 ft	Deck width:	77 ft
Last inspection:	9/2/2009	Spans:	5
NBI:	Deck : 7	Super: 7	Sub: 8

4.1.1.1 Representative Figures



Figure 4.1. Bridge 27611 aerial view (Bing, 2011)

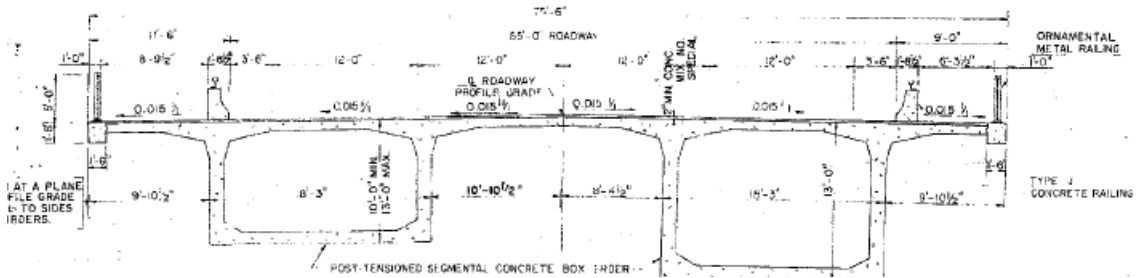

Figure 4.2. Bridge 27611 typical cross section view

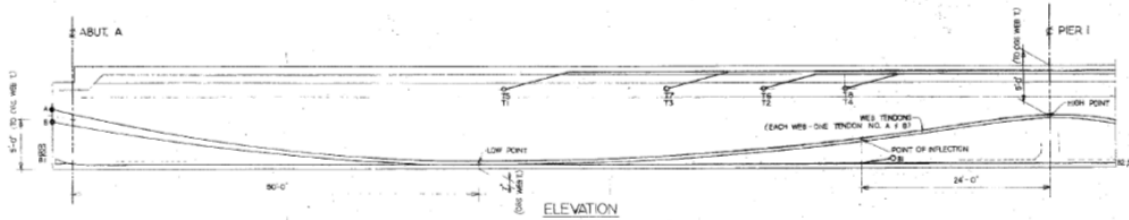

Figure 4.3. Bridge 27611 tendon profile view A

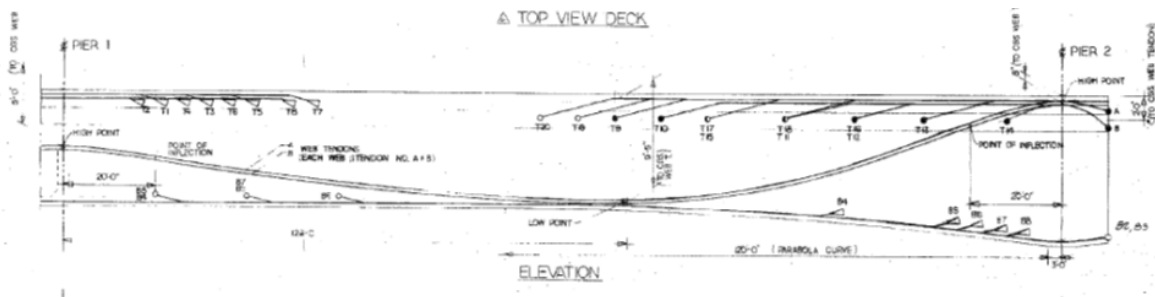

Figure 4.4. Bridge 27611 tendon profile view B

4.1.1.2 Inspection and Discussion Focusing on PT Indicators

This bridge was closed in the fall of 2010 due to evidence of major corrosion in the box girder due to a leaking drainage system inside the box girders. The City of Minneapolis hired a consultant (Corven Engineering) to evaluate the bridge and to recommend repair options. Additionally, this bridge was then included for inspection under the MnDOT contract that is sponsoring this report. Andrea Schokker and the inspection team from VStructural, LLC did an inspection on site in December of 2010 (see in Plymouth Avenue Bridge section of report). These detailed findings are given in the Plymouth Avenue Bridge section of the report.

4.1.1.3 Detailed inspection recommendation= 10

4.1.2 Bridge 27262 (LRT)

District:	Metro	City:	Minneapolis
Year built:	2002	Bridge Type:	PT box girder
Facility:	LRT	Feature:	TH 55, Ramp, Lake Street
Length:	2072 ft	Deck width:	49.0 ft
Last inspection:	4/29/2008	Spans:	15
NBI:	Deck : 8	Super: 8	Sub: 8

4.1.2.1 Representative Figures



Figure 4.5. Bridge 27262 aerial view (Bing, 2011)

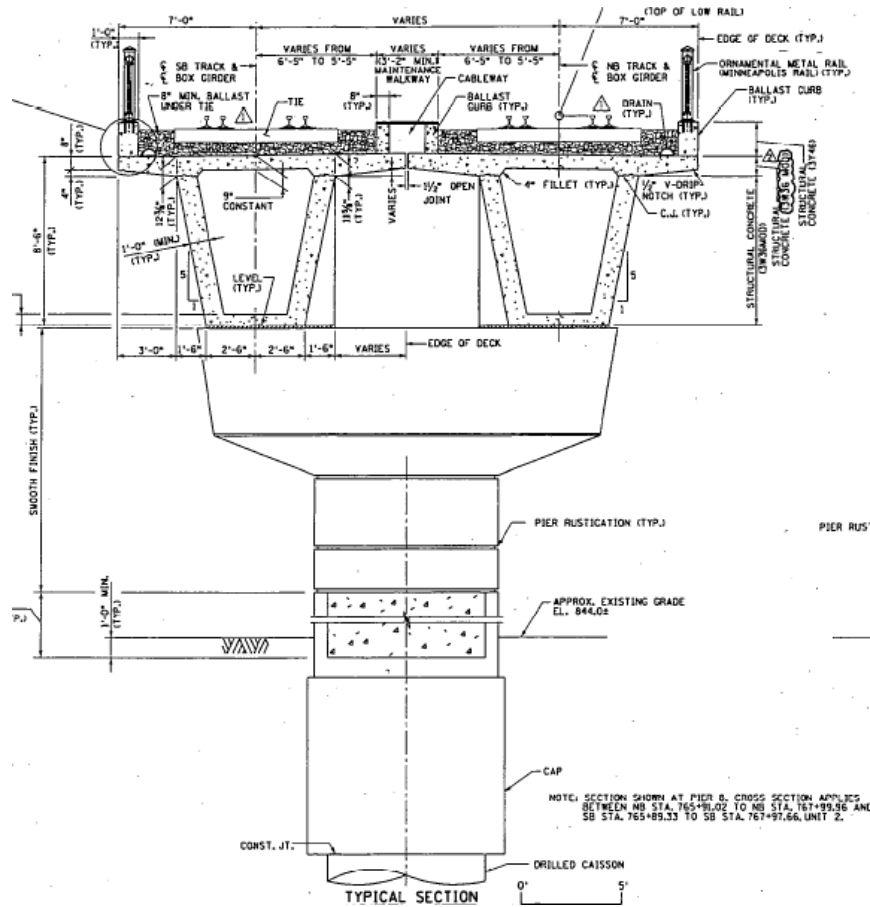

Figure 4.6. Bridge 27262 typical cross section view

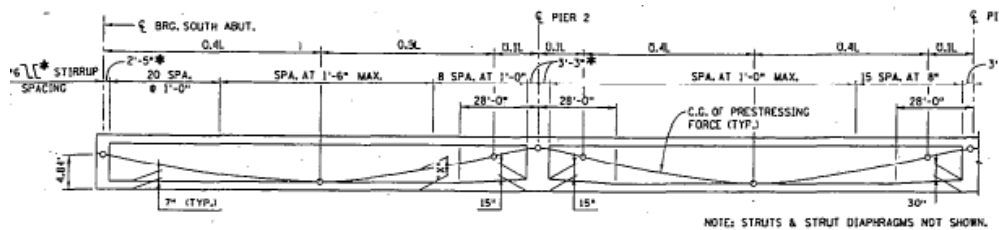

Figure 4.7. Bridge 27262 tendon profile view

4.1.2.2 Inspection Notes Focusing on PT Indicators

- Void in east girder north of pier #14 (9" deep) with large amount of grout on top of bottom slab that has emanated from the void
- 11" void in span 11 with grout on bottom slab in numerous locations in this area
- Minor cracking with efflorescence in soffit slab
- 4 ft long horizontal cracks around the center web access openings
- Horizontal cracking in W fascia web of the N intermediate diaphragm in span 14

4.1.2.3 Discussion Focusing on PT Indicators

This light rail bridge has some warning signs of problems during construction as detailed in the inspection notes. Voiding, grout from the void, and grout on the bottom slab indicate the

possibility of blowouts/leaks during construction and the likelihood that the structure is not fully grouted.

4.1.2.4 Detailed inspection recommendation = 10

4.1.3 Bridge 02037 E

District:	Metro	City:	Coon Rapids
Year built:	1997	Bridge Type:	PT box girder
Facility:	US 10 EB	Feature:	University Ave & MN 610
Length:	479 ft	Deck width:	49.21 ft
Last inspection:	9/28/2009	Spans:	3
NBI:	Deck : 7	Super:	8
			Sub: 7

4.1.3.1 Representative Figures



Figure 4.8. Bridge 02037 E aerial view (Bing, 2011)

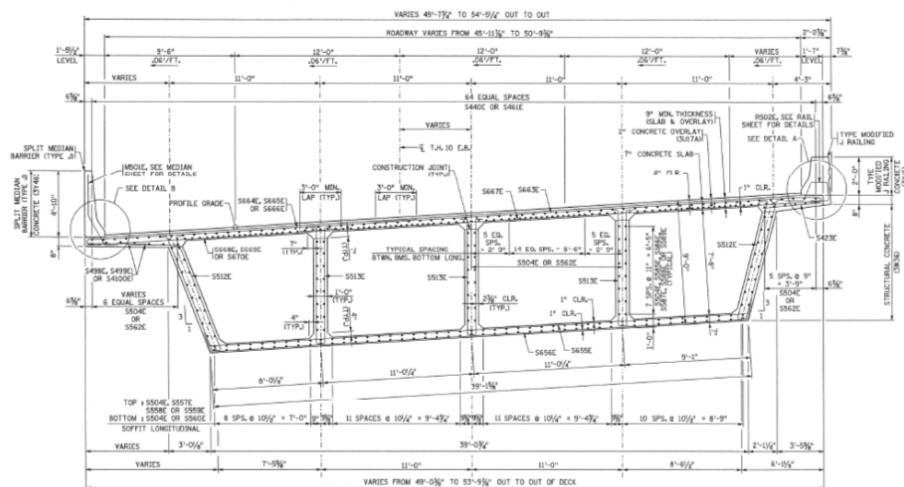

Figure 4.9. Bridge 02037 E typical cross section view

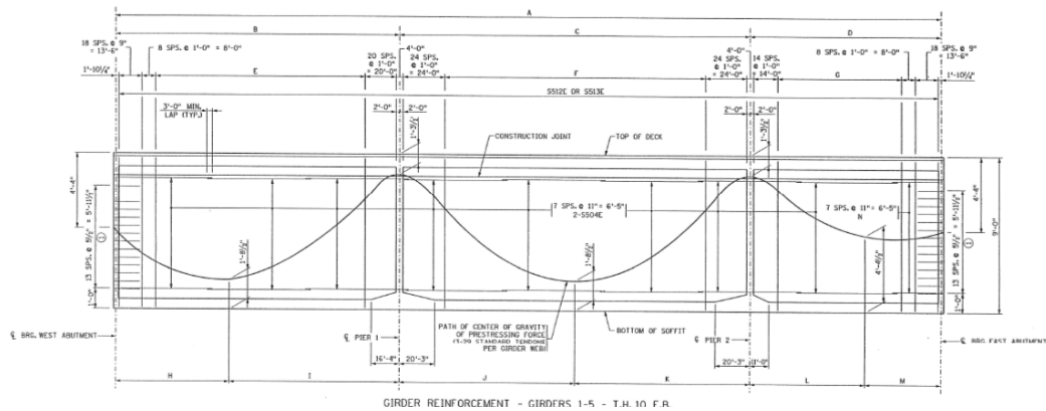

Figure 4.10. Bridge 02037 E tendon profile view

4.1.3.2 Inspection Notes Focusing on PT Indicators

- Deck has 3 sq ft of delamination near east end block
- Deck cracking (2400 linear feet)
- Leaching cracks at coping under deck

4.1.3.3 Discussion Focusing on PT Indicators

The 2009 inspection notes do not indicate anything with respect to the PT boxes, but with NBI ratings of 7 for the deck, 8 for the superstructure and 7 for the substructure, a more detailed visual inspection related to PT elements was warranted. This structure has significant box girder height and thus the PT tendons have a fairly high vertical rise. The high points in this case would be susceptible to a potentially substantial amount of voiding from bleed water collection. The tendons contain 27 strands and this will contribute to bleed as well. Discussions with MnDOT personnel indicate that some problems were also encountered on site during grouting and that a ready-mix truck was used for mixing some of the grout (more likely on the westbound structure). This combination of potential problems make this set of bridges a good candidate for more detailed inspection.

4.1.3.4 Detailed inspection recommendation = 9

4.1.4 Bridge 02037 W

District:	Metro	City:	Coon Rapids
Year built:	1997	Bridge Type:	PT box girder
Facility:	US 10 WB	Feature:	University Ave & MN 610
Length:	597 ft	Deck width:	49.21 ft
Last inspection:	9/28/2009	Spans:	4
NBI:	Deck : 7	Super:	8
		Sub:	7

4.1.4.1 Representative Figures



Figure 4.11. Bridge 02037 W aerial view (Bing, 2011)

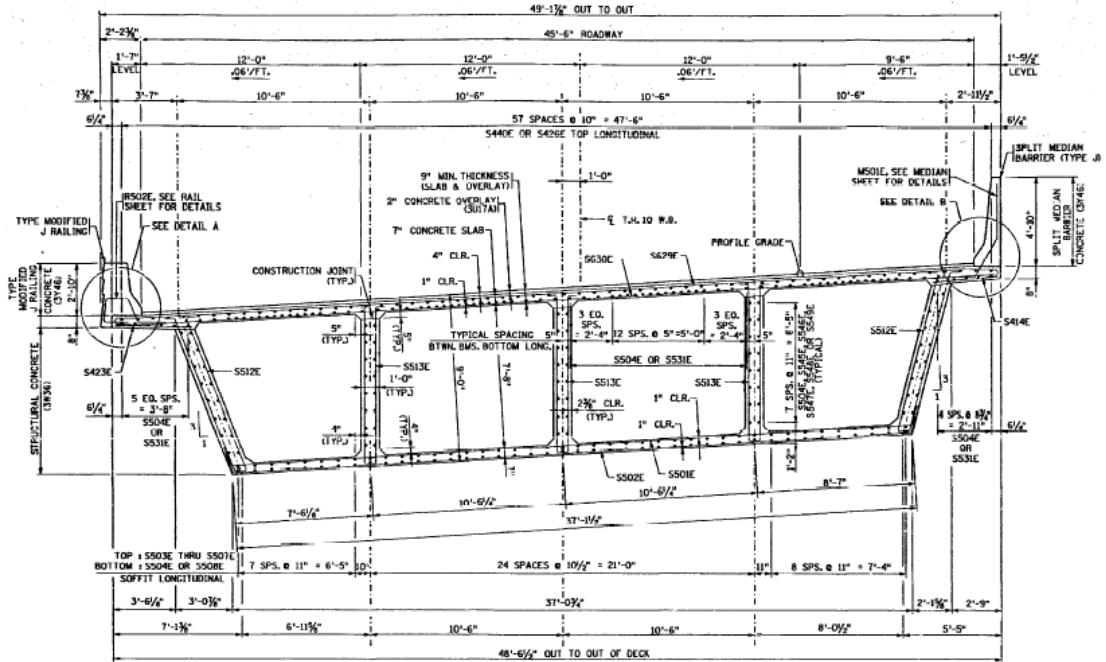

Figure 4.12. Bridge 02037 W typical cross section view

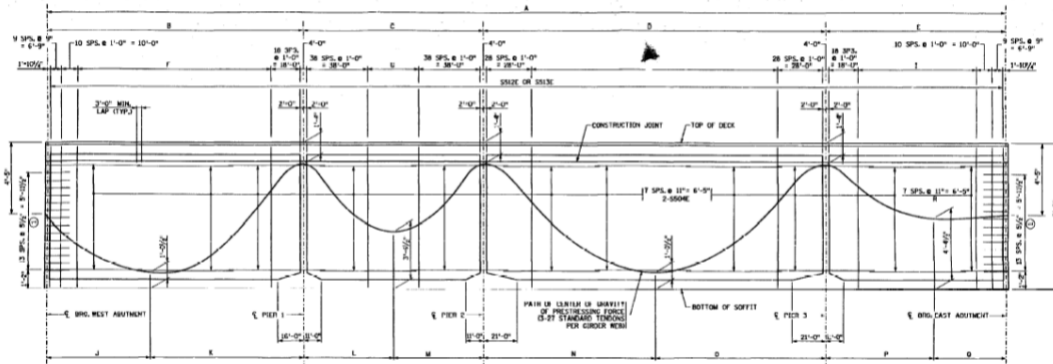

Figure 4.13. Bridge 02037 W tendon profile view

4.1.4.2 Inspection Notes Focusing on PT Indicators

- Deck has 4 sq ft of delamination (2 sq ft spalling) at west end block; 1 sq ft spalling at east end block

4.1.4.3 Discussion Focusing on PT Indicators

This is the sister structure to 02037E. Similar concerns exist at tendon high points. No information is given in the 2009 inspection report about the PT boxes. This structure was potentially more of a concern than the eastbound structure due to grouting procedures observed on site by MnDOT personnel. This structure was chosen for invasive inspection and details of that inspection are given in a later section.

4.1.4.4 Detailed inspection recommendation = 9

4.1.5 Bridge 9350 (Dartmouth)

District:	Metro	City:	Minneapolis
Year built:	1994	Bridge Type:	CSTL BM SPAN
Facility:	I 94	Feature:	Mississippi R, Ramp
Length:	1001 ft	Deck width:	141.3 (varies)
Last inspection:	10/8/2009	Spans:	6
NBI:	Deck : 7	Super:	6
		Sub:	7

4.1.5.1 Representative Figures



Figure 4.14. Bridge 9350 aerial view (Bing, 2011)

Plans reviewed but not included in this report (non-public data)

4.1.5.2 Inspection Notes Focusing on PT Indicators

- PT caps added in 1995 (river piers #3, 4, 5); cracks and leaching in #5

4.1.5.3 Discussion Focusing on PT Indicators

This bridge was originally constructed in 1963 with PT bent caps as part of reconstruction in 1994-1995. The combination of elevation and transverse profile changes in the tendons, cored holes for tendons into existing columns, and importance of end anchorage coverage make this a bridge a good target for a more detailed inspection during the next cycle of routine inspections.

4.1.5.4 Detailed inspection recommendation = 9

4.1.6 Bridge 27719

District:	Metro	City:	Minneapolis
Year built:	1982	Bridge Type:	PT box girder
Facility:	Lyndale Ave N	Feature:	Shingle Creek
Length:	93 ft	Deck width:	70.3 ft
Last inspection:	8/17/2009	Spans:	1
NBI:	Deck : 7	Super: 8	Sub: 8

4.1.6.1 Representative Figures



Figure 4.15. Bridge 27719 aerial view (Bing, 2011)

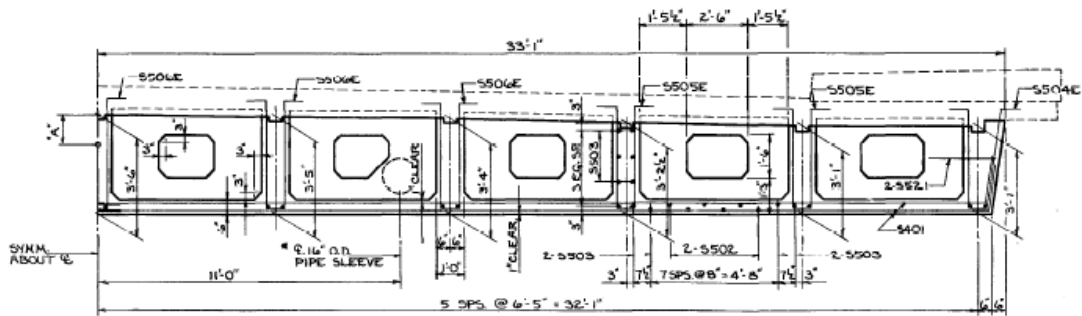

Figure 4.16. Bridge 27719 typical cross section view

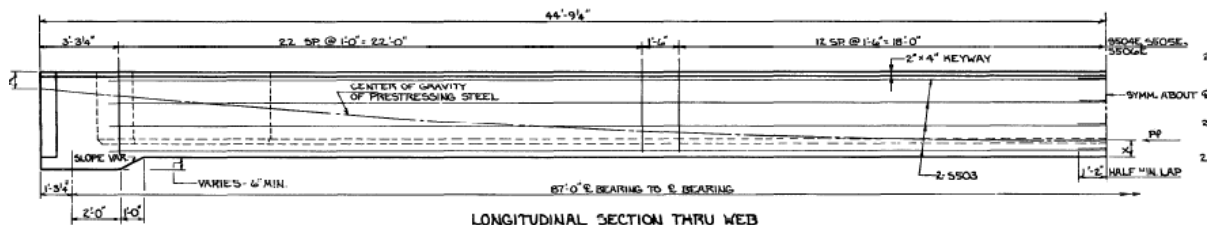

Figure 4.17. Bridge 27719 tendon profile view

4.1.6.2 Inspection Notes Focusing on PT Indicators

- Deck: sealed and unsealed longitudinal cracks as well as map cracking
- Snooper used to evaluate PT boxes (appears to include access into boxes)
 - Spalling and patching noted on diaphragms
 - Honey combing in one of the boxes (5th from west)
- Galvanized sheathing for bottom of deck inside boxes
- Some fine transverse cracks on underside of boxes

4.1.6.3 Discussion Focusing on PT Indicators

Spalling and/or patching is mentioned for nearly all diaphragms inspected. A visual inspection inside the box should be done with particular focus on whether the cracking or spalling is related to the post-tensioning or in an area that would make the post-tensioning tendons more susceptible to corrosion.

4.1.6.4 Detailed inspection recommendation = 8

4.1.7 Bridge 69818 N

District:	1	City:	Duluth
Year built:	1985	Bridge Type:	PT box girder
Facility:	0.3 Mi SW of JCT 5 th Ave	Feature:	I-35 (NB & SB)
Length:	2736 ft	Deck width:	42.4 ft
Last inspection:	10/09/2008	Spans:	30 (see drawings)
NBI:	Deck : 7	Super:	7
			Sub: 8

4.1.7.1 Representative Figures



Figure 4.18. Bridge 69818 N ground view

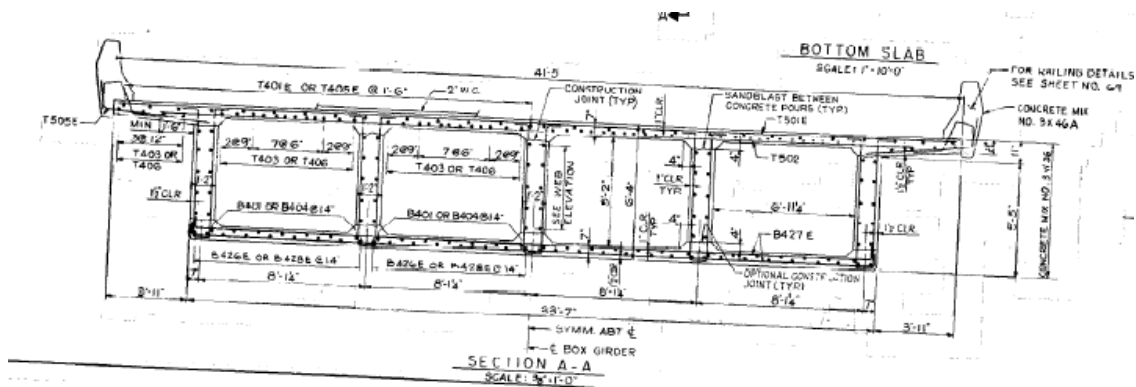

Figure 4.19. Bridge 69818 N cross section view A

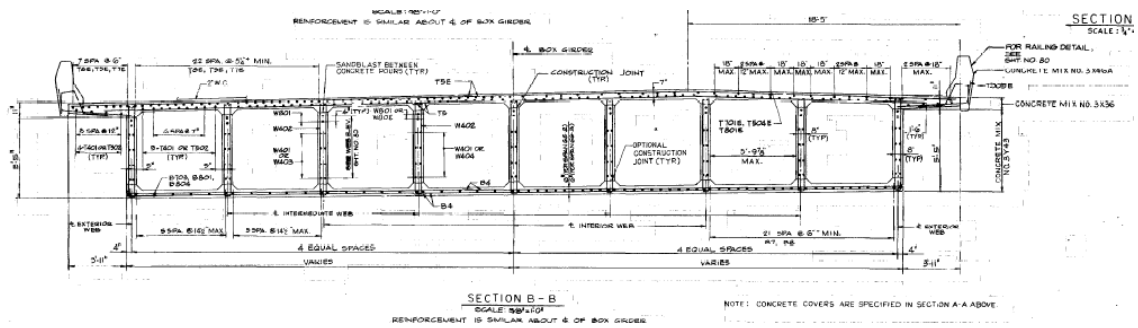

Figure 4.20. Bridge 69818 N cross section view B

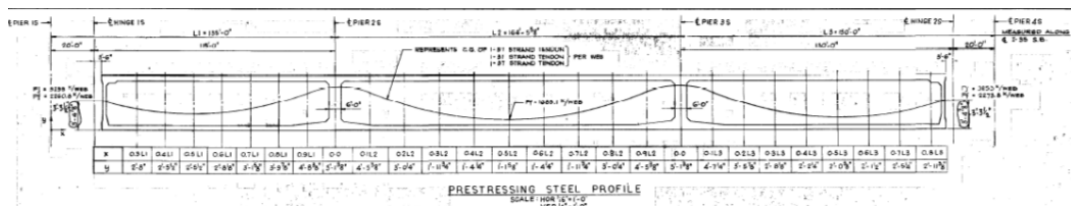

Figure 4.21. Bridge 69818 N typical tendon profile view A

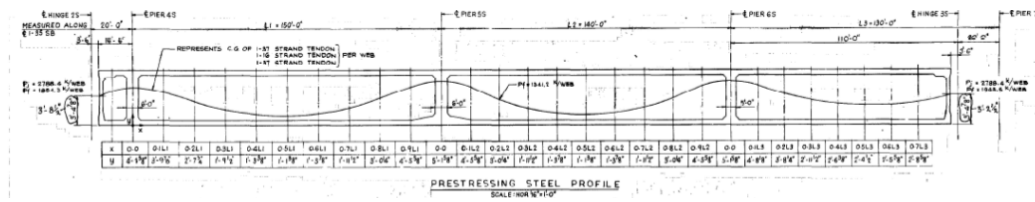

Figure 4.22. Bridge 69818 N typical tendon profile view B

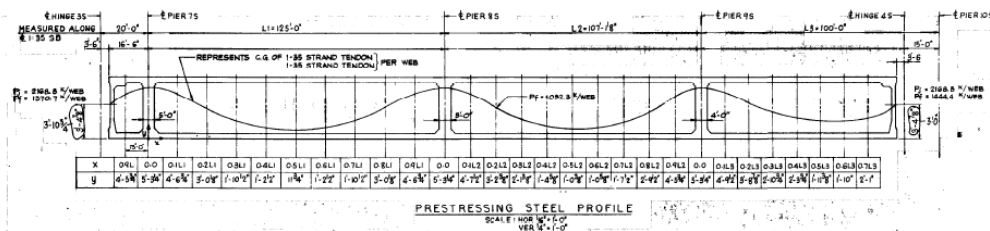

Figure 4.23. Bridge 69818 N typical tendon profile view C

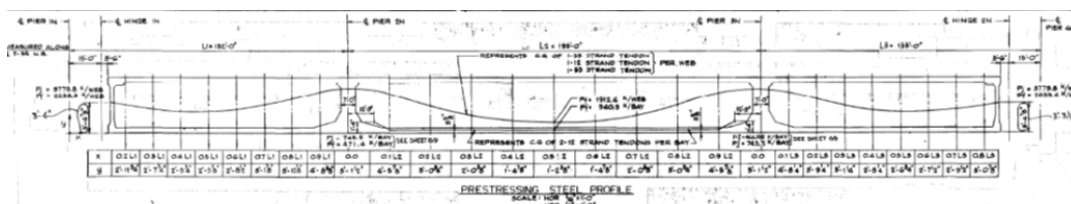

Figure 4.24. Bridge 69818 N typical tendon profile view D

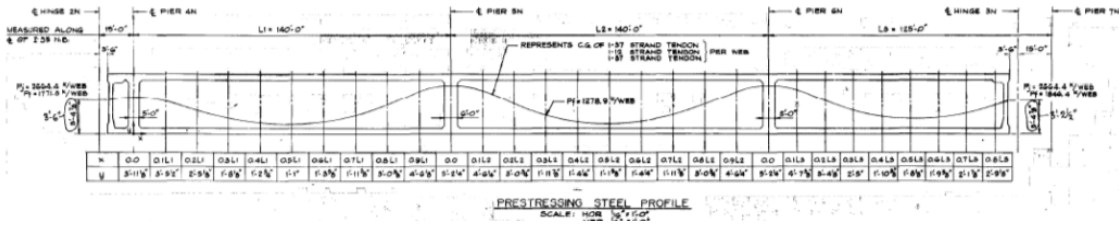

Figure 4.25. Bridge 69818 N typical tendon profile view E

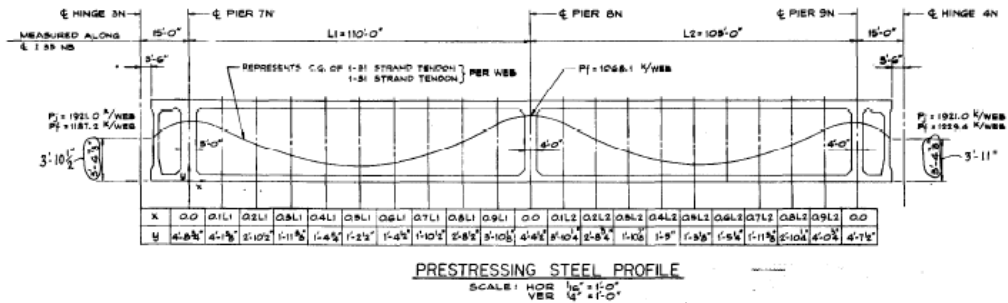

Figure 4.26. Bridge 69818 N typical tendon profile view F

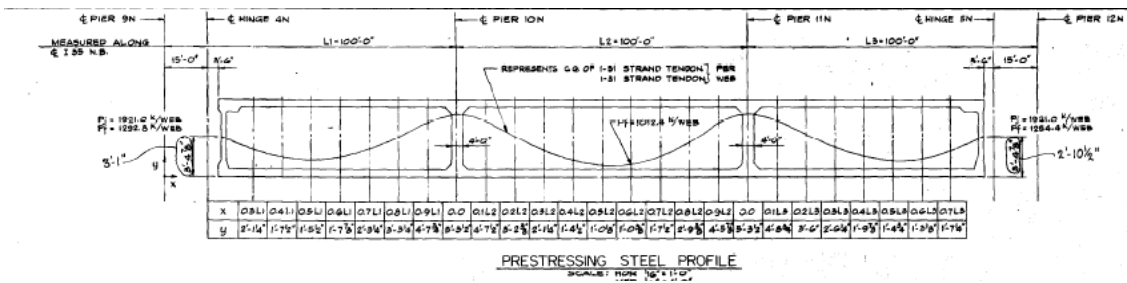

Figure 4.27. Bridge 69818 N typical tendon profile view G

4.1.7.2 Inspection Notes Focusing on PT Indicators

- Inspection by snooper
- Consultants unable to access interior of boxes
- Deck spalling and heavy cracking
- Large spalls in poured deck joint
- Plugged and clogged drains
- Web cracking (vertical and shear) including at end diaphragms
- Delaminated areas in box section

4.1.7.3 Discussion Focusing on PT Indicators

This multi-cell box girder bridge has relatively large internal tendons (up to 37 strands per duct) in a parabolic profile. The grout used in the mid-80's for this structure was highly unlikely to be bleed resistant and may have included expansive admixture. The combination of the large number of tendons to be grouted, tendon size, tendon profile, and potential drainage issues make this structure a good candidate for invasive inspection at likely void locations. Selected anchor

regions should be checked via borescope to determine the extent of voids (if any) along with the condition of the strand. Intermediate high points coincide with diaphragm areas, so selected locations just outside the diaphragm should be targeted to investigate voids away from the anchor region.

An internal visual inspection of the box should be completed to look for signs of problems in the web tendons. The inspection reports describe web cracking that may indicate loss of tendon capacity or the cracking may have been in place since original stressing. Spalling in the deck and particularly at the poured joint may point to areas of potential ingress for moisture and chlorides into the box. The condition of the interior of the box with respect to visual indicators of moisture ingress is important to isolate potential problem areas.

4.1.7.4 Detailed inspection recommendation = 8

4.1.8 Bridge 69818 S

District:	1	City:	Duluth
Year built:	1985	Bridge Type:	PT box girder
Facility:	I 35 SB	Feature:	SL&LC RR & TH 194 NB
Length:	2,732 ft	Deck width:	42.4 ft
Last inspection:	8/18/2008	Spans:	~30 (Reference Plans)
NBI:	Deck : 7	Super:	7 Sub: 8

4.1.8.1 Representative Figures



Figure 4.28. Bridge 69818 S aerial view (Bing, 2011)

See Bridge 69818 N for Cross Section and Tendon Profile Views

4.1.8.2 Inspection Notes Focusing on PT Indicators

- Light vertical cracks with efflorescence at regular intervals along girders
- Shear cracks in all girder walls and some leaching in cracks at end of girders
- Notes indicate inspection inside in 2007 (not available)

4.1.8.3 Discussion Focusing on PT Indicators

This is the sister structure to 69818N. The inspection reports for the two structures differ (and had different inspectors), but both indicate a significant amount of cracking. This structure should be investigated further along with 69818N.

4.1.8.4 Detailed inspection recommendation = 8

4.1.9 Bridge 02034

District:	Metro	City:	Coon Rapids
Year built:	1996	Bridge Type:	PT box girder
Facility:	US 10 EB on Ramp	Feature:	MN 47 SB
Length:	407 ft	Deck width:	55.77 ft
Last inspection:	9/17/2009	Spans:	3
NBI:	Deck : 7	Super: 8	Sub: 7

4.1.9.1 Representative Figures



Figure 4.29. Bridge 02034 (Bing, 2011)

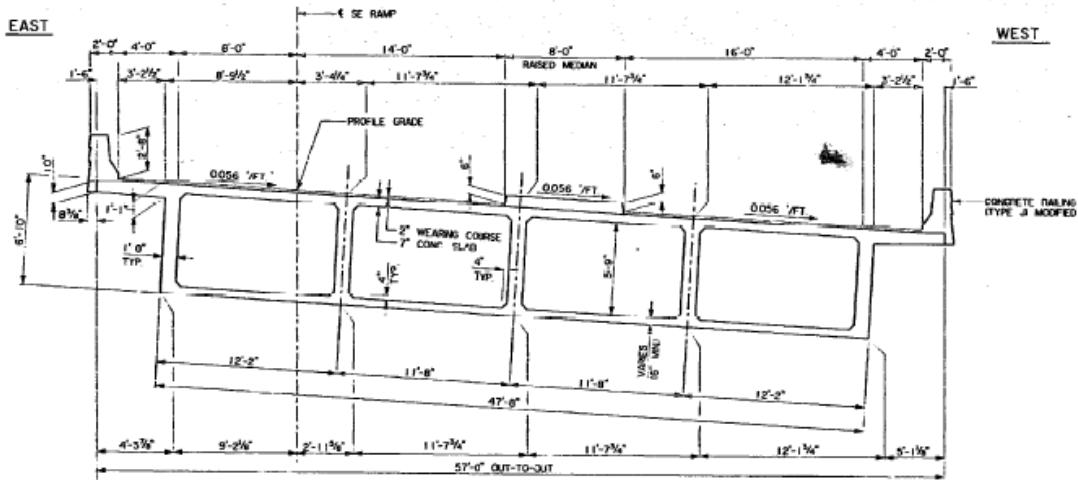

Figure 4.30. Bridge 02034 typical cross section view

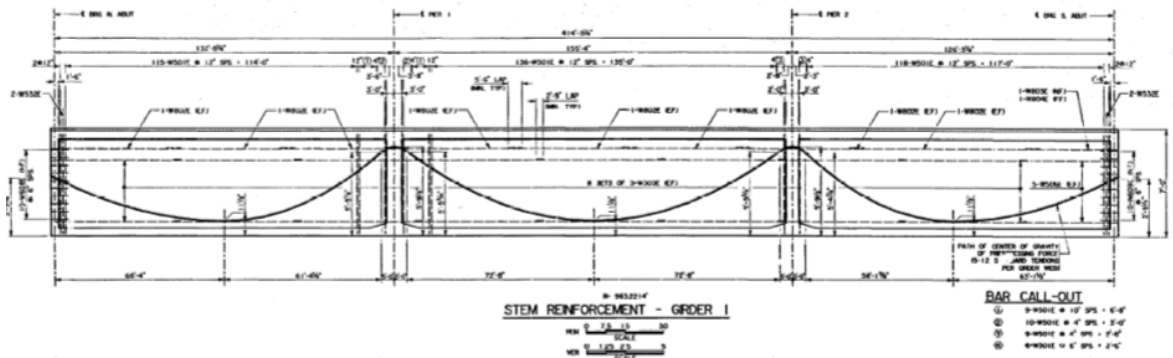

Figure 4.31. Bridge 02034 tendon profile view A

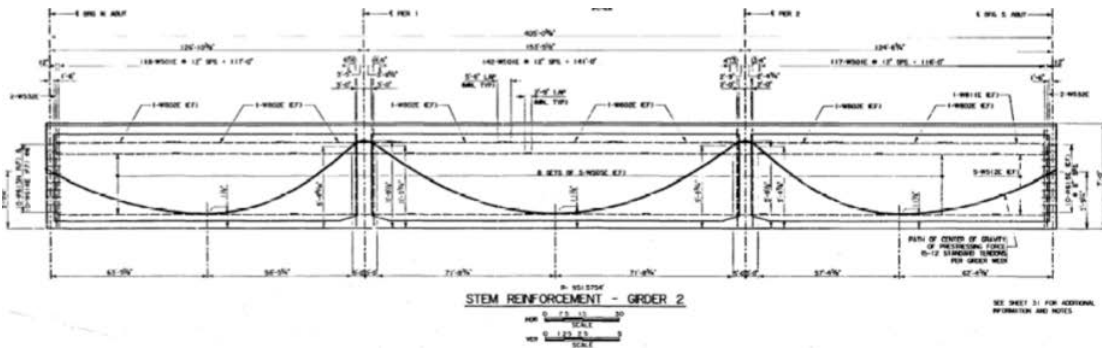

Figure 4.32. Bridge 02034 tendon profile view B

4.1.9.2 Inspection Notes Focusing on PT Indicators

- PT pier cap #1 has vertical cracks with leaching
- Deck cracking up to 1/4" width
- Cracking inside boxes

4.1.9.3 Discussion Focusing on PT Indicators

Deck cracking of ¼” is significant. Cracking requiring epoxy fill inside the box is also of interest as a sign of PT related problems or potential for corrosion. A full visual inspection of the box interiors is recommended for this bridge. The 2009 inspection report does not have any information specific to the PT boxes. The parabolic drape profile does not have a tall vertical rise, but this layout may be susceptible to bleed problems near intermediate high points and end anchors.

4.1.9.4 Detailed inspection recommendation = 8

4.1.10 Bridge 9030 (Blatnik)

District:	1	City:	Duluth
Year built:	1992	Bridge Type:	CSTL High TRUSS
Facility:	I 535	Feature:	St Louis R, RR, Street
Length:	7980 ft	Deck width:	63.7 (varies)
Last inspection:	7/29/2009	Spans:	23
NBI:	Deck : 6	Super: 5	Sub: 6

4.1.10.1 Representative Figures



Figure 4.33. Bridge 9030 aerial view (Bing, 2011)

Plans reviewed but not included in this report (non-public data)

4.1.10.2 Inspection Notes Focusing on PT Indicators

- PT pier caps had shrinkage cracking that was repaired shortly after construction; nearly identical cracks visible on each pier cap

4.1.10.3 Discussion Focusing on PT Indicators

The PT components in this bridge are the PT pier caps. The inspection notes do not indicate any problem areas related to the PT other than the recorded cracking. End anchorage protection should be visually inspected during routine inspections. The end protection for the anchorages as shown in the plans indicate good defense. Plastic end caps are recommended for current construction, but were not typically used at the time of this construction. Metallic caps (that were typically removed) were often used. Indications of cracking, efflorescence and/or rust staining would be indicators of the need for a more detailed inspection. The overall recommendation for inspection of this bridge related to PT is low, however it has been given an

“8” based on the reported cracking in the piers. The inspection notes indicate a need for further inspection specific to the PT pier caps.

4.1.10.4 Detailed inspection recommendation = 8

4.1.11 Bridge 70037

District:	Metro	City:	Shakopee
Year built:	1994	Bridge Type:	PSTN SD BM SPAN
Facility:	US 169 EB	Feature:	MSAS 131
Length:	180 ft	Deck width:	44.2 ft
Last inspection:	7/16/2009	Spans:	1
NBI:	Deck : 7	Super:	7
		Sub:	7

4.1.11.1 Representative Figures



Figure 4.34. Bridge 70037 aerial view (Bing, 2011)

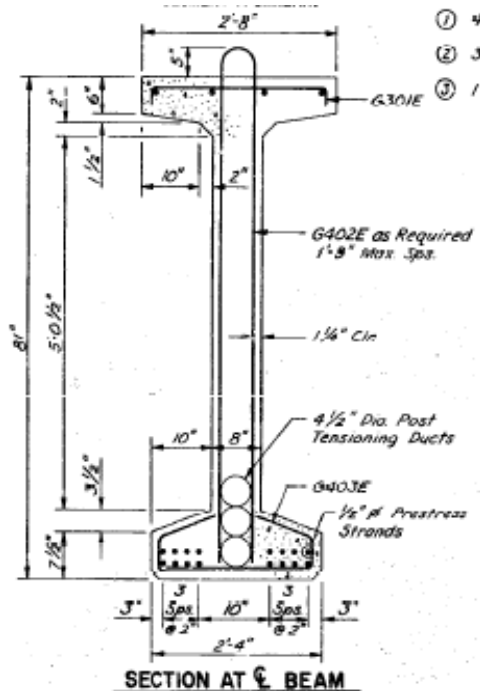

Figure 4.35. Bridge 70037 typical cross section view A

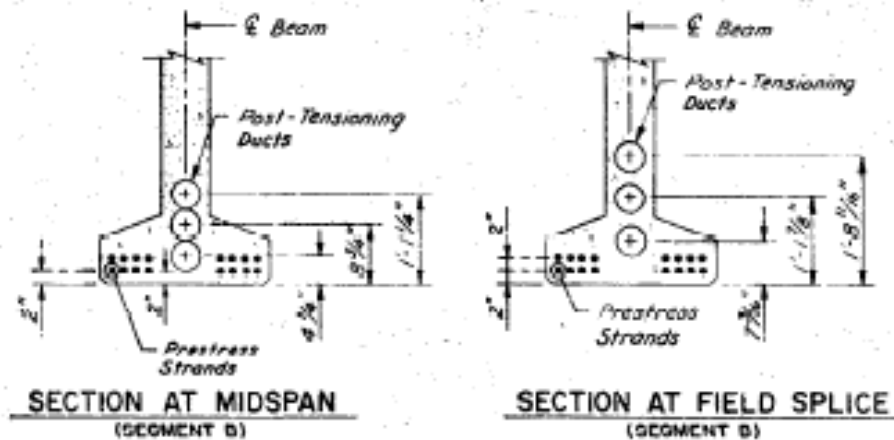

Figure 4.36. Bridge 70037 typical cross section view B

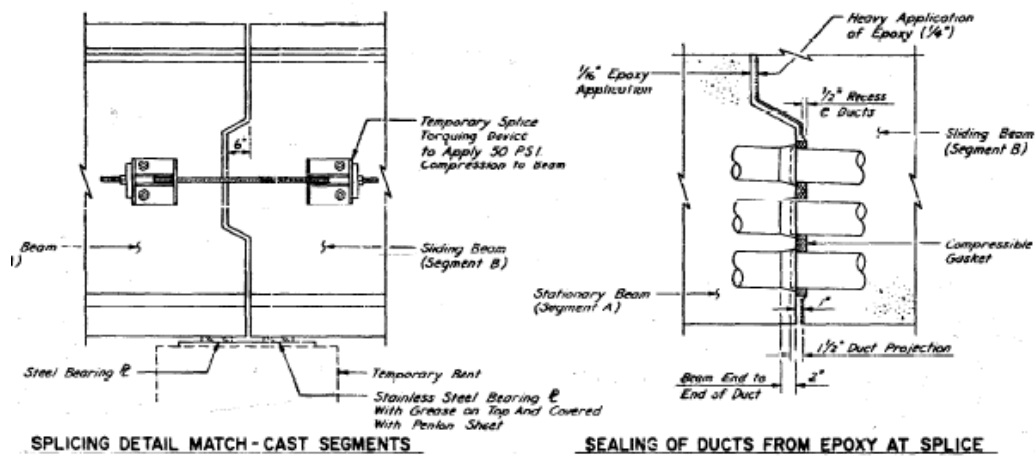

Figure 4.37. Bridge 70037 typical cross section view C

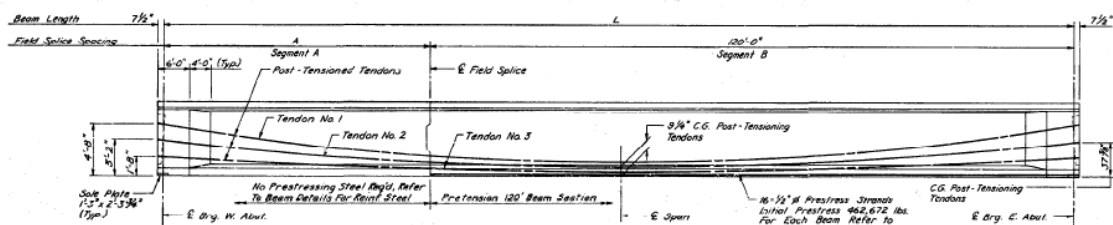

Figure 4.38. Bridge 70037 tendon profile view

4.1.11.2 Inspection Notes Focusing on PT Indicators

- Overlay delamination and scaling near end block (not likely to be related to PT for this type of system)
- Joint failures

4.1.11.3 Discussion Focusing on PT Indicators

This spliced PT girder bridge has no problems directly related to the PT girders indicated in the 2009 inspection report. However, due to the relatively few number of spliced girder bridges in MN (and the United States in general), visual inspection of the splices is of interest. The girder depth is considerable, so bleed potential at high points is closer to that of a box girder bridge.

4.1.11.4 Detailed inspection recommendation = 7 (spliced PT)

4.1.12 Bridge 70038

District:	Metro	City:	Shakopee
Year built:	1994	Bridge Type:	PSTN SD BM SPAN
Facility:	US 169 WB	Feature:	MSAS 131
Length:	180 ft	Deck width:	46.5 ft
Last inspection:	7/16/2009	Spans:	1
NBI:	Deck : 7	Super:	7
		Sub:	7

4.1.12.1 Representative Figures



Figure 4.39. Bridge 70038 aerial view (Bing, 2011)

See Bridge 70037 for Cross Section and Tendon Profile Views

4.1.12.2 Inspection Notes Focusing on PT Indicators

- Overlay delamination and scaling near end block (not likely to be related to PT for this type of system)
- Joint failures

4.1.12.3 Discussion Focusing on PT Indicators

See discussion under sister structure Bridge 70037.

4.1.12.4 Detailed inspection recommendation = 7 (spliced PT)

4.1.13 Bridge 27547

District:	Metro	City:	Minneapolis
Year built:	1970	Bridge Type:	PSTN SD SLAB SPAN
Facility:	Chicago Ave	Feature:	Minnehaha Creek
Length:	53 ft	Deck width:	67 ft
Last inspection:	6/30/2009	Spans:	1
NBI:	Deck : 7	Super:	7
		Sub:	8

4.1.13.1 Representative Figures



Figure 4.40. Bridge 27547 aerial view (Bing, 2011)

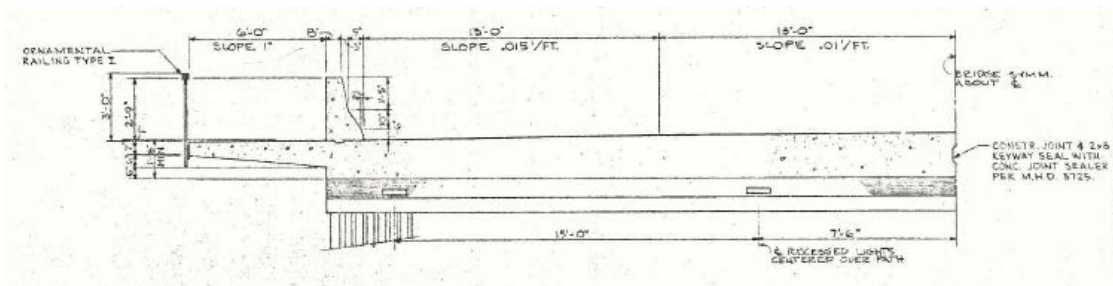

Figure 4.41. Bridge 27547 cross section view

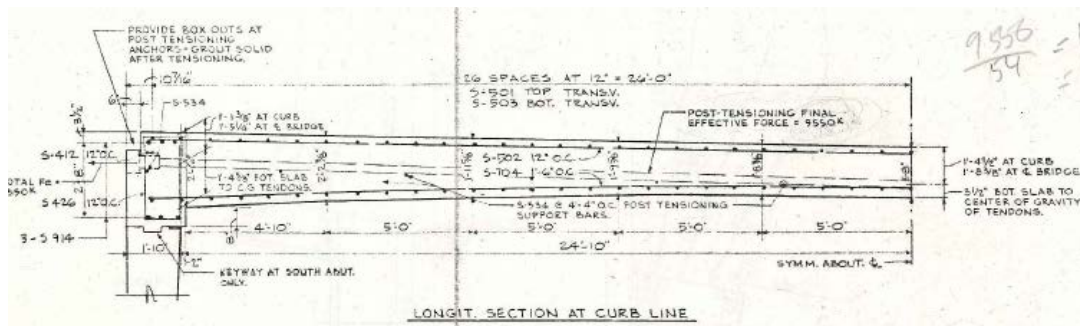

Figure 4.42. Bridge 27547 tendon profile view

4.1.13.2 Inspection Notes Focusing on PT Indicators

- Deck surface has minor uniform scaled, 3 sealed longitudinal full depth cracks, and some small spalls at the longitudinal joint line
- Underside of deck has a fine longitudinal cracks with efflorescence
- Underside has some spall at the outside edges with rebar exposed

4.1.13.3 Discussion Focusing on PT Indicators

This PT slab bridge has cracking as would be expected in a bridge of this age. The tendon profile has little vertical rise, so bleed problems should be minimal. The end anchorage details should be visually inspected for signs of corrosion. This is the oldest PT bridge listed in the MnDOT inventory, so is of interest for brief visual inspection under this contract from that perspective.

4.1.13.4 Detailed inspection recommendation = 4

Chapter 5 Visual Inspection of Select PT Bridges in Minnesota

The University of Minnesota Duluth (UMD) did visual inspections on the ten post-tensioned bridges that received the highest inspection recommendation during the preliminary classification as described in Chapter 4. Inspections consisted of an exterior examination either from ground level, from the bridge deck, or with use of a snooper truck (if already onsite for other inspections). A search for signs of distress related to the post-tensioning system of the structure was the focus of the visual inspection. The bridges are in order of decreasing inspection recommendation.

The bridges that underwent an extensive visual inspection, as well as the three bridges that underwent invasive inspections are not included in this section of the report since they are detailed in later chapters. For inspection notes on Plymouth Avenue Bridge (bridge ID #27611), I-35 N/S Bridge (bridge ID #69818N/S), US 10 EB Bridge (bridge ID #02037 E/W), Blatnick I-535 Bridge (bridge ID #9030), and US 10 EB On Ramp Bridge (bridge ID #02034) see respective section in report.

5.1 Bridge 27262 (LRT)

The bridge received an inspection recommendation of 10 (see section 4.1.2 for justification). Despite receiving this high recommendation rating, the bridge was not chosen for invasive inspection under this contract since it is a light rail bridge rather than a road bridge (the structure is owned by Metro Transit). During the visual inspection no obvious issues were found on the exterior of the structure related to PT. Figure 5.1 shows an overview of a portion of the structure.



Figure 5.1. Overview of bridge 27262

An inspection of the numerous access hatch doors showed no corrosion on the steel indicating there is no trapped water within the box girder. Figure 5.2 shows a typical access hatch along the bottom of the box girder.



Figure 5.2. Access hatch of bridge 27262

The abutment at one end of the structure had a substantial amount of discoloration. Figure 5.3 shows this discoloration, which is not staining any parts of the PT box girders.



Figure 5.3. Discoloration of abutment

A closer look at one of the box girders showed signs of minor honeycombing. This is an indication of poor consolidation at the time of construction. Figure 5.4 shows a sample of the honeycombing that was observed along the bottom of the box girders.



Figure 5.4. Honeycombing along bottom of box girder

A visual inspection of the bridge from the ground where access was possible showed no immediate areas of concern, however an inspection inside the box is recommended. An invasive inspection focusing in locations indicated by the inspection notes would provide more detail about potential voiding and corrosion in the tendons.

5.2 Bridge 9350

The bridge received an inspection recommendation of 9 (see section 4.1.5 for justification). The visual inspection was done from a distance due to access issues (lane closures and snooper needed to access pier caps). From the very limited sight line from ground inspection, no signs of PT cracking could be observed. Figure 5.5 shows the main span across the Mississippi River.



Figure 5.5. Main spans across the Mississippi River

A closer look at the pour back area showed no signs of PT related cracking. Figure 5.6 shows a close-up of a typical pour back area on the post-tensioned pier.



Figure 5.6. Post-tensioned pier cap

During the next routine inspection for the bridge, the pier caps should be evaluated for cracking related to post-tensioning along the length of the pier cap and in the pour back area.

5.3 Bridge 27719

The bridge received an inspection recommendation of 8 (see section 4.1.6 for justification). During the visual inspection some indications of potential PT related issues were seen. Figure 5.7 shows an overview of the single span of the bridge. Visual access from the ground is relatively good, but access to the interior of the bridge would require a snooper and lane closures due to the conditions under the bridge (creek and pedestrian trail).



Figure 5.7. Bridge 27719 overview picture

Below one of the access hatch coverings was evidence of grout spillage. An area of approximately 3 square feet (.91 square meters) has heavy grout splatter which is a potential indication of grouting issues during construction. Two possible causes of the grout splatter are most likely: grout from venting that was not captured or leakage during grouting. The tendon above this area should be inspected (through invasive drilling and borescope) to determine if voids are present. Figure 5.8 shows the grout splatter on the slope near the abutment.



Figure 5.8. Grout splatter beneath access hatch

Cracking was observed running along the bottom of the box girders that extended in the longitudinal direction from the abutment into the span. Figure 5.9 shows these cracks along the bottom of the box girders (highlighted in yellow). These cracks may be related to the location of the PT tendon and also can provide access of moisture and other aggressive agents to the duct. When the inspection is done to evaluate the tendon in the area of the grout spill, an inspection of the inside of the box sections should also be conducted with particular focus near the end region cracked area.



Figure 5.9. Cracking along box girder

5.4 Bridge 70037/70038

The bridge received an inspection of recommendation of 7 (see section 4.1.11 for justification). The bridge had no major problem indicators, but received this relatively high recommendation since it is one of the few spliced PT bridges in Minnesota. Visual inspection showed no indicators of PT related distress. Figure 5.10 shows one of the splice regions – no problems were noted for any of the splice areas.



Figure 5.10. Splice region

Near the drainage system some light staining was seen. Figure 5.11 shows this staining that was seen on the exterior girder of the structure. Based on the condition of the bridge (visual inspection from the ground and review of documentation), no recommendations for additional inspection are needed at this time.



Figure 5.11. Moisture staining on exterior girder

5.5 Bridge 27547

The bridge received an inspection of recommendation of 4 (see section 4.1.13 for justification). The bridge was of interest due to the age of the structure. Further investigation of the bridge revealed signs of wear that would be consistent with similar bridges built at that time. Figure 5.12 shows the structure spanning over the Minnehaha Creek.



Figure 5.12. Bridge 27547 spanning across the Minnehaha Creek

Cracking was seen in various regions along the bottom of the slab span, but none that had direct indications of PT distress in the structure. Figure 5.13 shows the slab span across the underlying creek.



Figure 5.13. Slab span of bridge 27547

Areas of concrete spalling were seen at various locations of the structure, but this is expected in a structure of this age. The locations of the spalling did not indicate any issues with the PT of the structure. Figure 5.14 shows the spalling and moisture staining at the abutment as well as cracking. The structure's regular inspections are sufficient at this time (no special PT related inspections needed).



Figure 5.14. Spalling at abutment of bridge 27547

Chapter 6 Plymouth Avenue Bridge (Bridge ID #27611) in Minneapolis

Opening in 1983, the Plymouth Avenue Bridge spans across the Mississippi River in Minneapolis, Minnesota. The bridge is a post-tensioned box girder bridge spanning 934 feet (284.68 meters), with a deck width of 75.5 feet (23.01 meters) consisting of two parallel twin concrete box girders with varying depth of 10 to 13 feet (3.05 to 3.96 meters). The Plymouth Avenue Bridge was the first bridge in Minnesota that incorporated the use of segmental bridge technology. Spans 1, 2, 4 and 5 were cast-in-place on false work with two internal post-tensioned web tendons. The tendons are comprised of 19, ½ in (1.27 cm) strands contained in a 3.5 in (8.89 cm) spiral wound metal duct. The tendons are draped in elevation to produce an eccentricity across the spans that coincides with the resulting moment. Construction of the 260 ft (79.25 m) main span (span 3 running between pier 2 and pier 3) used cast-in-place cantilever segments with embedded anchorage blisters (to the neighboring span 2 and 4) that were stressed for each 16.5 ft (5.03 m) segment. Identical cantilever sections were constructed from both the east and westward side. A 9 ft (2.74 m) closure joint was poured to join the cantilevers and slab continuity tendons tied the cantilevered sections together. Seen below in figure 6.1 is a graphical representation of the Plymouth Avenue Bridge elevation (with span and pier labels) and cross section views (with web labels).

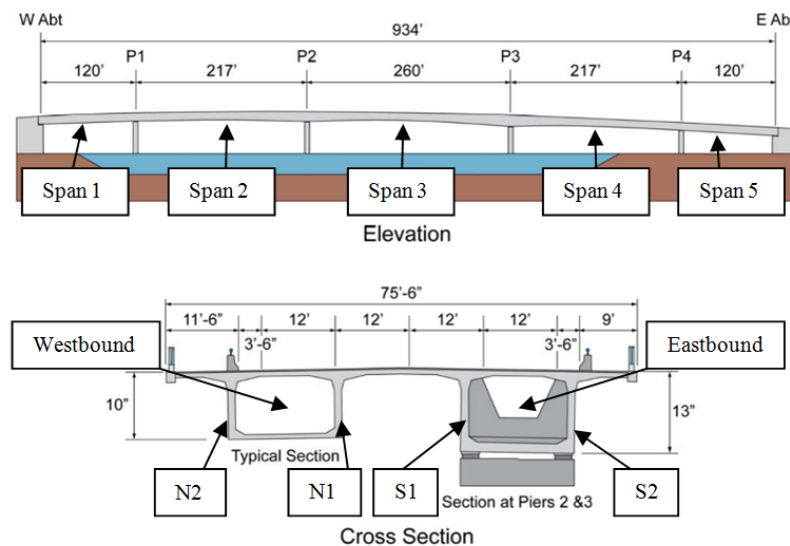

Figure 6.1. Elevation and cross section view of Plymouth Avenue Bridge (Corven Engineering, 2010)

6.1 Initial Bridge Inspection Performed by Corven Engineering

During an annual bridge inspection, the Plymouth Avenue Bridge was noted as having slab cracking and evidence of corrosion in the form of rust stains. An additional inspection was performed on October 12, 2010 as a follow-up where limited removal of loose concrete cover revealed an extensive amount of cracking in the bottom slab, as well as confirmed active corrosion in the bottom slab continuity tendons. These findings prompted the city of Minneapolis to contract Corven Engineering to further investigate the damage.

An inspection of the bridge was performed on October 21st and 22nd, 2010 by Corven Engineering and Minneapolis City personal. The investigation consisted of a visual inspection of the roadway surface, and the interior/exterior of several of the concrete box girders. Also included in the inspection was a limited removal of bottom slab concrete to understand the extent of the bridge deterioration, as well as a performance check of the embedded drainage system by way of flooding the eastbound box girder. The findings of this inspection led to the bridge closure until a further investigation could be completed.

6.1.1 Observations from Investigation by Corven Engineering (2010 report)

The visual inspection of the 2 in (5.1 cm) concrete roadway surface indicated cracking patterns that would be consistent with similarly built PT box girder bridges that experience comparable exposure conditions. Evidence of routine maintenance was seen in the form of a flowable epoxy crack sealant. During the investigation of the top slab, transverse cracking was seen along the width of the bridge from both the exterior and interior of the box girders in spans 1, 2, 4 and 5. This cracking was seen in regions over the piers where tension is most prevalent, as well as over the middle of the span where compression is typical under service loading. These cracks were determined to likely be the result of the temporary tensile stress that was created during the cantilever construction of span 3. From these cracks, efflorescence is seen, but there were no signs of rust staining.

The web had both diagonal tensile cracking as well as cracking along the profile of the draped internal post-tensioned tendons. The diagonal tensile cracking caused by shear stress in the web was most evident in the exterior box girders, but was also observed in the interior box girders of span 3. It was indicated by the records that the cracks were produced during construction. Epoxy was injected into the cracks in the interior box girders, and a cementitious white coating was patched on the cracks of the exterior at some point as a repair tactic. The diagonal cracking in the exterior box girders extends though the repair coating indicating tensile stresses being imposed on the bridge after the repair was done. There is also cracking following the draped tendon profile, with more prevalent cracks in the exterior web of the box girders. Spotted efflorescence was observed extending through these cracks.

The bottom slab of the continuity tendons in all spans had the most extensive reported damage. From the exterior of the box girders, cracking was present in the length of the bottom slab on both the eastbound and westbound box girders. Efflorescence as well as rust staining is present extending from the cracks, as well as concrete spalling from the bottom of the slabs. This damage is not visible from the interior of the box girders. Seen below in figure 6.2 is the bottom slab damage looking east to west from the exterior.



Figure 6.2. Bottom slab damage east to west view (Corven Engineering, 2010)

Also seen in figure 6.2 (above) is a drainage outlet that was tested during the inspection. The drainage system collects water from an inlet at the top slab where it flows through pipes that are running through the interior of the box girders. Figure 6.3 shows a graphical representation of the drainage system of the bridge. To test the drainage system, the south half of the bridge was flooded (over the eastbound box girder). This flooding resulted in water being present within the interior of the box girder above some of the damaged areas of the exterior of the bottom slab. This is a clear indication of leaks in the drainage system. During a closer investigation, attempted repair seals could be seen at various locations in the drainage system, although not all leaks were sealed.

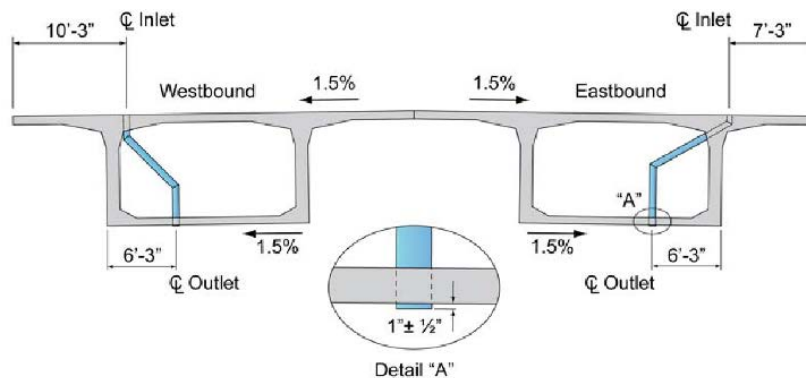

Figure 6.3. Drainage system representation (Corven Engineering, 2010)

Water from the drains was also present on the underside of the bottom slabs. As seen in figure 6.3, the drainage outlet has minimal extension beyond the bottom slab. When the volume of discharge diminished, the water would flow along the bottom of the slab following the 1.5 percent pitch in the longitudinal direction towards the exterior of the box girder. Corrosion

appeared around these areas of the water flow, and with removal of cracked concrete, corrosion of the spiral wound galvanized metal duct and the prestressing strand was present. Figure 6.4 shows the rust staining around the outlet duct and the corrosion on the steel reinforcement, galvanized ducts and prestressing strands.



Figure 6.4. Bottom slab drainage outlet (Corven Engineering, 2010)

A jackhammer was used to remove a limited portion of damaged concrete in the bottom slab of the main span (span 3) at mid-span. Five of the ten tendons in the exposed area are visible. One of these tendons has corroded completely through, and the other four exposed tendons have broken strands as well as cross section loss to the prestressed strand (of varying degrees). The other unexposed tendons produced a hollow sound when struck with a hammer. Figure 6.5 shows the exterior (bottom) of the exposed post-tensioning and in figure 6.6 is the interior of the same segment.



Figure 6.5. (Left) Exposed post-tensioned tendons view exterior (Corven Engineering, 2010)

Figure 6.6. (Right) Exposed post-tensioned tendons view from interior of box girder (Corven Engineering, 2010)

6.2 Invasive Investigation Performed by VStructural

The findings by Minneapolis personal and Corven Engineering were of interest to MnDOT under the work performed in this research contract. Invasive inspections under this contract were originally scheduled for spring/summer of 2011, but the opportunity to inspect the Plymouth Avenue Bridge moved the first inspection up. The inspection started on December 7, 2010 and was completed on December 11, 2010 by VStructural in cooperation with the PI, Dr. Schokker. Investigation locations included all spans in both the eastbound and westbound structures of each span. Locations to check bottom slab post-tensioned continuity tendons were chosen after a visual inspection and noticeable distress points were identified in the concrete. Post-tensioned web tendons were chosen as a systematic spot check of high points near abutments and piers (of interest for grouting condition). Included in the investigation report are photos taken by VStructural during the inspections, as well as select design drawings.

6.2.1 Span 1 Eastbound and Westbound Structures

The span 1 inspection consisted of a visual inspection, as well as drilling inspection holes into 6 locations along the post-tensioned tendons in the webs of the box girder. Figure 6.7 shows an elevation view of web S1 (interior web of eastbound box girder) and web N1 (exterior web of westbound box girder) of span 1. Highlighted with a circle (yellow for eastbound, blue for westbound) on the figure are the approximate locations that were drilled for tendon access during the inspection (this applies to all elevation views in this section of the report).

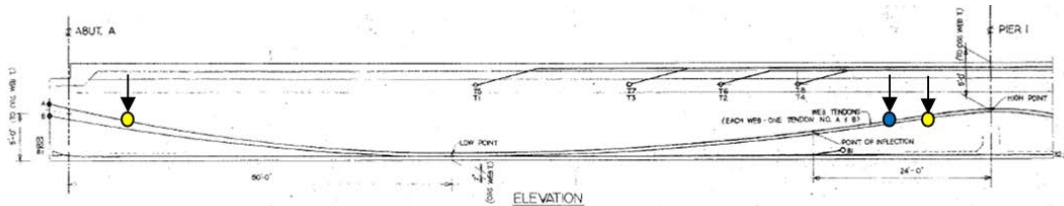

Figure 6.7. Span 1 web S1 and web N1 elevation view

Figure 6.8 shows the elevation view of web S2 (the exterior web of the eastbound box girder) and web N2 (exterior web of westbound box girder).

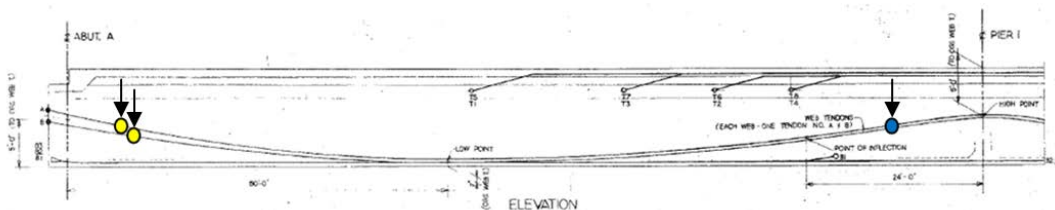

Figure 6.8. Span 1 web S2 and web N2 elevation view

All web duct inspections done in span 1 were found to have clean and dry ducts with no voids detected, and no moisture seen. The grout in all the ducts appeared to be solid and of good color. Figure 6.9 shows an overview photo of the drilled hole into tendon A, in web S2 that is located 10.17 feet (3.1 meters) from abutment A (a representation of a typical drilled hole in span 1).

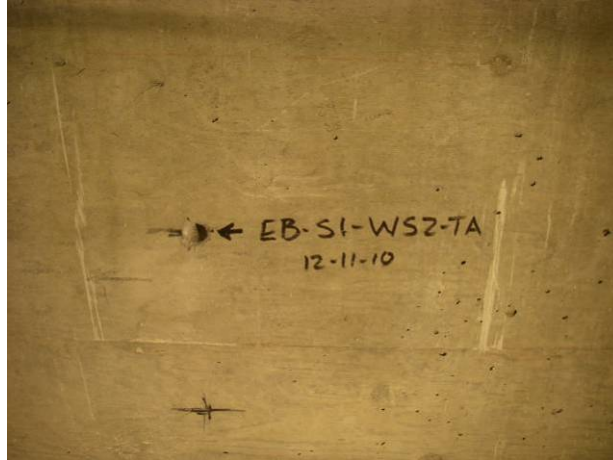

Figure 6.9. Overview photo of drilled hole into span 1 web S2 tendon A

Figure 6.10 shows a picture taken with the borescope inside of the drilled hole in web S2 of Span 1 as seen above. The metal duct is visible in the picture with no signs of corrosion. One wire of one of the cables can also be seen, and no signs of corrosion are visible. The grout within the duct also is solid and of good color.

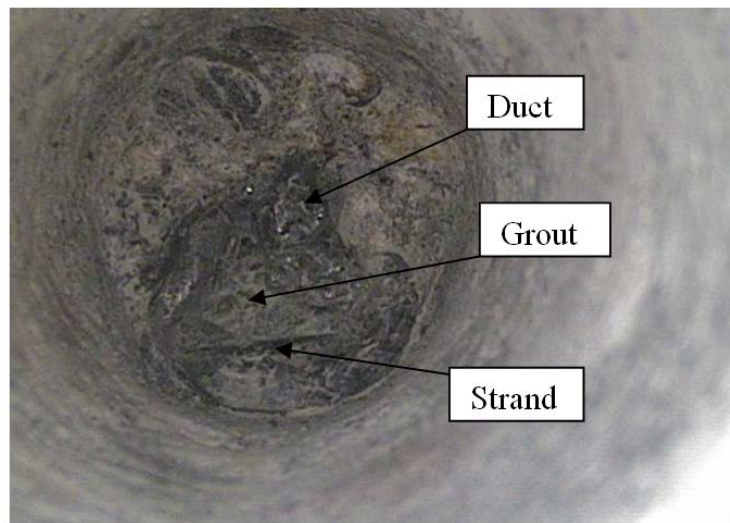

Figure 6.10. Borescope picture of drilled hole in web S2 of span 1

6.2.2 *Span 2 Eastbound and Westbound Structures*

A visual inspection showed signs of cracking that followed the profile of the bottom slab continuity tendons. Cracks found along the drains of the structure will likely worsen with time, and potentially lead to similar issues as are present in span 3 and 4 (as will be discussed in later sections). Figure 6.11 shows a picture taken in the eastbound structure of span 2. Cracking can be seen in this photo (black marker lines were drawn to highlight these cracks) along with moisture trails from the cracks.



Figure 6.11. Cracking in span 2 eastbound structure

Following the visual inspection of span 2, four locations in the eastbound structure, and four locations in the westbound were drilled into to expose the post-tensioned tendons. Figure 6.12 shows an elevation view of web S1 (interior web of eastbound box girder) and web N1 (interior web of westbound box girder) of span 2.

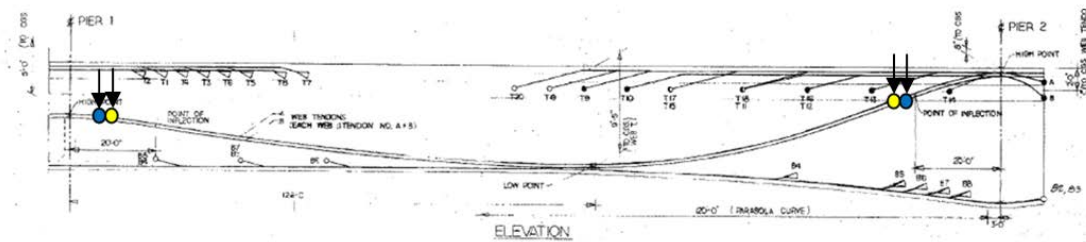

Figure 6.12. Span 2 web S1 and web N1 elevation view

Figure 6.13 shows the elevation view of web S2 (the exterior web of the eastbound box girder) and web N2 (exterior web of westbound box girder).

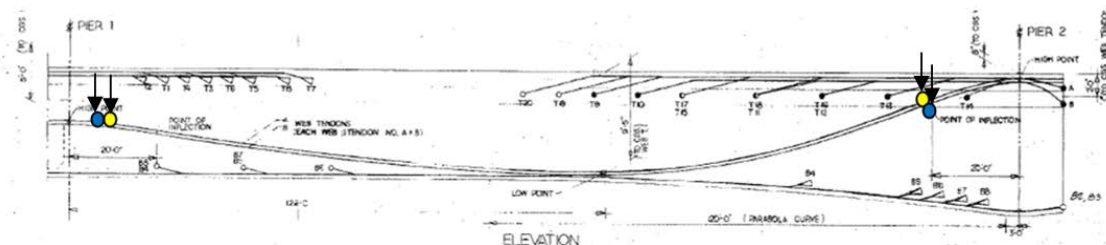

Figure 6.13. Span 2 web S2 elevation view

All web duct inspections done in span 2 were found to have clean and dry ducts with no voids detected, and no moisture seen. The grout in all the drill holes appeared to be solid and of good color. Figure 6.14 is an overview photo of the drilled hole into tendon B in web N1 that is located 24.83 feet (7.57 meters) from pier 2 (representation of all inspection holes drilled in span 2).



Figure 6.14. Overview photo of drilled hole into span 2 web S2 tendon B

Seen below in figure 6.15 is the picture taken with the borescope inside of the drilled hole in web S2 of Span 2 as seen above. The metal duct is visible in the picture with no signs of corrosion. The grout within the duct is seen to be solid and of good color.

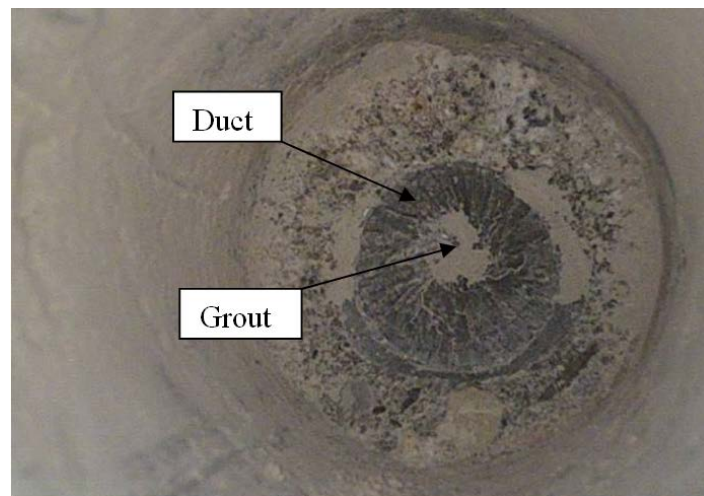

Figure 6.15. Borescope picture of drilled hole in web S2 of span 2

6.2.3 Span 3 Eastbound Structure

Cracking and concrete spalls are common in the eastbound span, with the concentration of the web cracks being located on the exterior web (web S2). Most of the bottom slab cracking is running parallel to the continuity tendons. Investigation of the closure pour area that had been exposed during the Corven Engineering inspection, showed signs of severe tendon corrosion. The post-tensioning ducts were completely deteriorated, and the strands had numerous wire

breaks with complete loss of the prestressing force. Of the ten continuity tendons in the bottom slab on the side of web S2, five showed signs of severe corrosion.

Within the eastbound structure, VStructural opened up what was believed to be a good section of duct from the bottom slab continuity tendons on the side of web S1. Found within the opened duct was a .125 inch to .25 inch (3.175 mm to 6.35 mm) bleed trail on the outside edge of tendon B15 (a bottom slab continuity tendon), but no significant voids. Figure 6.16 shows a top view of the bottom slab tendons, with a highlight (in yellow) on the opened duct (B15).

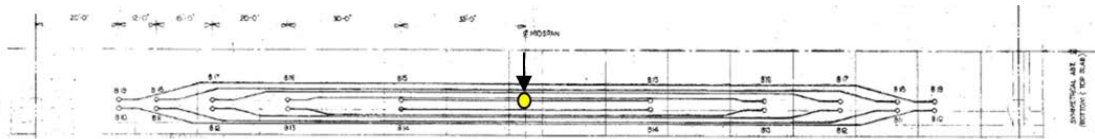

Figure 6.16. Span 3 towards web S1 top view bottom slab

Samples of the concrete were taken at 0 to 1 inch deep (0 to 2.5 cm) and 1 to 2 inches deep (2.5 to 5 cm) at the center span closure pour area, as well as at 4 feet (1.22 m) from center span towards pier 3. These samples were evaluated for acid soluble chloride content at the University of Minnesota Duluth (UMD). Figure 6.17 shows the results of the acid soluble chloride test conducted.

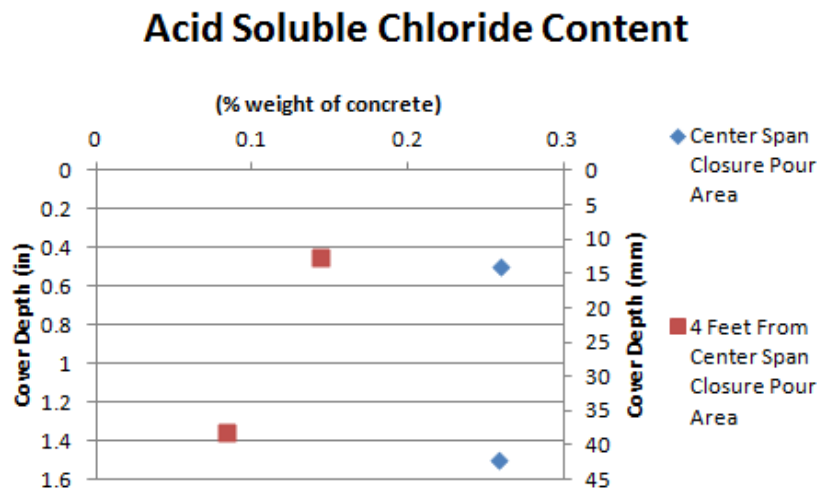

Figure 6.17. Acid soluble chloride content eastbound span 3

The literature varies widely on the threshold value of chloride levels for corrosion depending on access to moisture and oxygen and also dependent on the concrete mixture. The closure pour samples show levels of chloride that are significant enough to cause corrosion at the reinforcement depth and the investigation revealed active corrosion in this area. The chloride content is high in both sample depths in the closure pour. This may be somewhat related to data spread, but also leans toward direct ingress through cracks and/or very poor quality concrete.

The samples taken 4 ft (1.22 m) away from the closure pour show much lower chloride levels and have the expected reduction of chlorides with depth.

6.2.4 Span 3 Westbound Structure

The initial inspection done by Corven Engineering did not cover any of the continuity tendons in the westbound structure. Continuity tendons were examined by VStructural and Dr. Schokker at the closure pour near web N2. Tendons B17, B18 and B19 were examined near mid span (on exterior web N2 side of box girder) based on the visual evidence of the concrete condition in the bottom slab and were found to be corroded beyond recognition. Individual strands could not be distinguished due to the level of corrosion, and appeared as a large mass of corrosion product. Figure 6.18 shows the top view of the bottom slab tendons with a highlight on the section removed to expose tendons B17, B18 and B19.

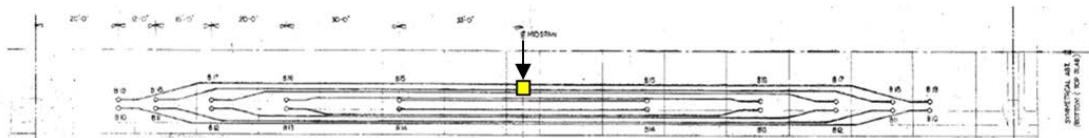

Figure 6.18. Span 3 towards web N2 top view bottom slab

Figure 6.19 shows the area at mid span of span 3, where corrosion can be seen bleeding through a spalling area. Figure 6.20 shows VStructural employees removing the concrete cover in the corroded area to expose the tendons (area shown in figure 6.18). Also notable in figure 6.20 is the corrosion seen on the electrical conduit running across interior of bottom slab which indicates the presence of a corrosive environment within the box girder.



Figure 6.19. (Left) Corrosion product under spalling area at mid span

Figure 6.20. (Right) Chipping cover from corroded area

Once the delaminated concrete cover had been removed (shown in figure 6.19), the extent of the corrosion was more evident. As seen in figure 6.21, the rebar in the slab is heavily corroded. Tendon 19 was exposed and the duct surrounding the post-tensioned strand was completely corroded away, leaving behind heavily corroded strand.

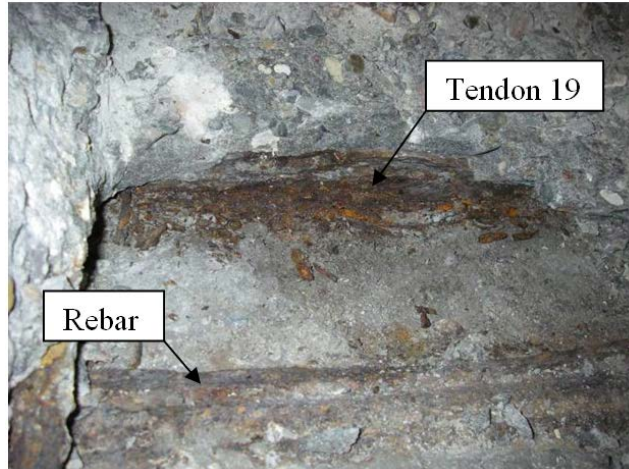

Figure 6.21. Corroded rebar and tendon 19

Samples of concrete were taken at several depths at this location to test for chloride content. Figure 6.22 shows the results of the acid soluble chloride test for these samples. Chloride content in this area was very high as would be expected given the extent of the corrosion of the reinforcement.

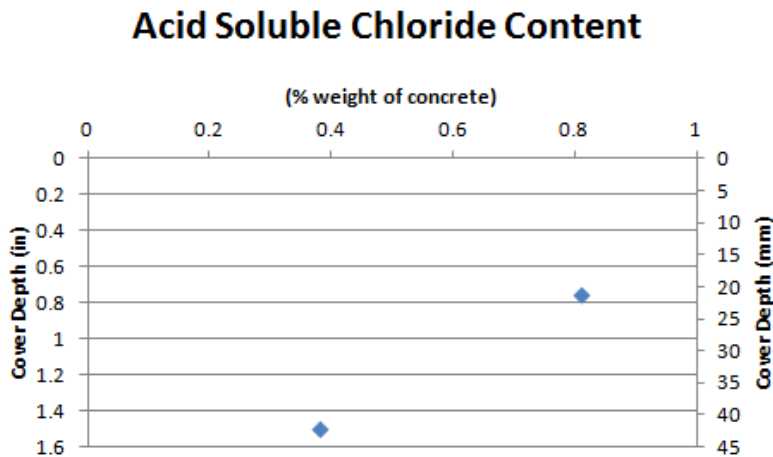

Figure 6.22. Acid soluble chloride results westbound span 3

Further removal of the concrete cover exposed tendons B18 and B17 as shown in figure 6.23 below. Like tendon B19, tendons B18 and B17 are corroded to the point that individual wires cannot be identified.



Figure 6.23. Overall view of opened/chipped area at mid span

Tendon 16 had an intact duct that was opened to expose the condition of the tendons. Figure 6.24 shows tendon 16 with an intact but heavily corroded duct.



Figure 6.24. Shows tendon 16 with corroded duct

A window was cut in the duct to inspect the grout and strand condition. The duct contained solid and good colored grout with a small bleed trail. Green rust (corrosion product produced in a low oxygen environment) was found in the bleed channel along with moisture as shown in figure 6.25. Other exposed cables in tendon 16 are in good condition and at corrosion class 1-2 based on Sason's classification (1992).



Figure 6.25. Opened tendon 16 with green corrosion product

Samples of grout were taken from tendon 16 and an acid soluble chloride test was conducted. The grout was found to contain 0.122 percent chloride by weight of grout.

Ducts B15 and B14 were also opened to check their condition. The exterior of the duct was found to be corroded so windows in the ducts were cut out. Tendons B15 and B14 were found to be full of good colored and solid grout. The strands were noted to be in good condition at class 1-2. Figure 6.26 shows tendon B15 with 3 exposed strands, and no visible corrosion.



Figure 6.26. Tendon B15 with removed window exposing multiple strands

Tendon B19 (toward web S2) was checked to evaluate the condition of the tendons on the opposite side of the box girder. This tendon was chosen due to a large crack directly over the duct. After chipping away a pocket to get access to the duct, it was found to be in good condition with no moisture and good colored solid grout. The grout was found to contain 0.075 percent chloride by weight of grout, which is under the limit on chloride in grout prior to being put in service.

6.2.5 Span 4 Eastbound Structure

A visual inspection was first performed on the structure on adjacent spans to look for distress points in the concrete. Cracking and spalling was found running nearly the entire length of the span. Figure 6.27 shows a crack running along the blister of the anchorage for tendons B28 and B24. Figure 6.28 shows the continuation of the crack along the length (highlighted with yellow) of the box girder, as well as delamination of concrete on bottom slab. In many areas the delaminated concrete on the bottom slab was a different color than the surrounding concrete, potentially indicating a massive amount of patching of the bottom slab after the initial concrete casting.



Figure 6.27. (Left) Crack along anchorage of tendon B28/B24

Figure 6.28. (Right) Crack along length of box girder

A location approximately 2 ft (.61 meters) in front of the bottom slab blister where continuity tendon B28 is anchored was selected for further investigation. An area of 6 inches by 6 inches (15.2 by 15.2 centimeters) was chipped away to expose the post-tensioned tendon. Figure 6.29 shows the top view of the bottom slab towards the web S2 on the exterior of the box girder with a highlight on the cut out section.



Figure 6.29. Span 4 towards web S2 top view bottom slab

Tendon B28 was corroded to the point of being an indistinguishable mass of corrosion product and no distinct grout sample could be taken. Samples were taken of the surrounding concrete at a depth of 0 to 1 inch (0 to 2.5 centimeters) and results acid soluble chloride testing are shown in figure 6.30. The chloride content in this area is high as would be expected based on the level of corrosion of the reinforcement.

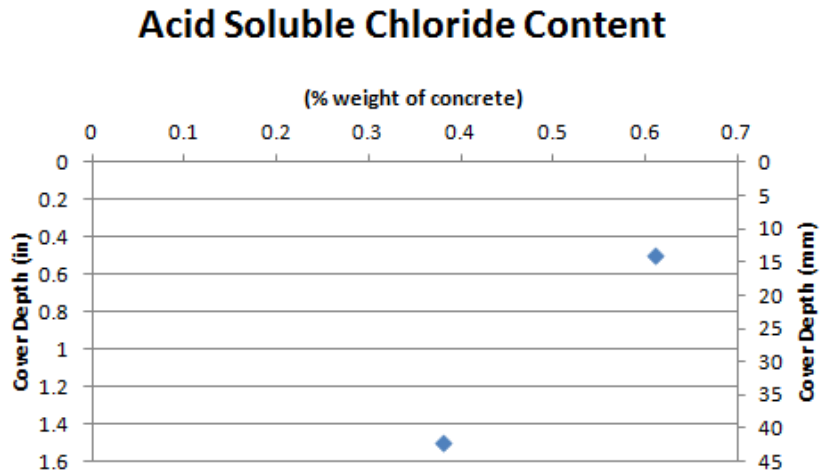

Figure 6.30. Acid soluble chloride test results eastbound span 4

Figure 6.31 shows the concrete cover being chipped away exposing tendon B28. Surrounding delamination can also be seen along area of opening. The delamination areas appear to be of a different concrete mixture than the bottom slab primary concrete. It is not known if these areas represent an attempt at patching uneven or cracked concrete during construction, but they are prevalent throughout the bottom slab. The patch concrete is delaminated/ separated in many areas allowing easy access for ingress of chlorides, moisture and oxygen.



Figure 6.31. Removal of concrete exposing tendon B28

A close up of the damage of the tendon is shown in figure 6.32. No distinction can be made of the individual strands, or of the difference between the grout and the corrosion product from the tendons.



Figure 6.32. Corrosion on tendon B28

Two locations were drilled along Web S2 to inspect the tendons within the webs. Figure 6.33 shows an elevation view of web S1 (interior web of eastbound box girder). Highlighted on the figure are the approximate locations that were drilled into during inspection. When the web was tapped in these locations, a clean and dry duct was found with solid grout of good color filling the duct. In the drilled hole near pier 3 one wire of strand was exposed and had no visible corrosion.

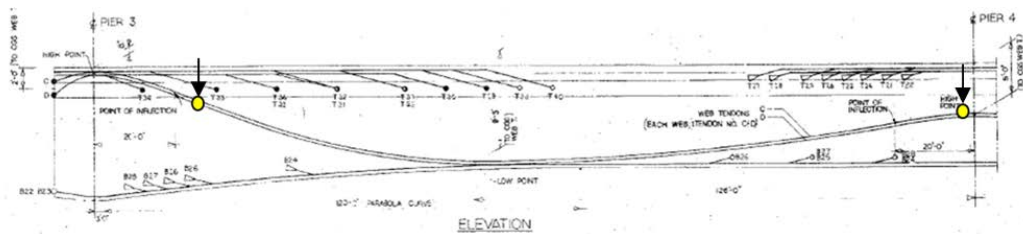

Figure 6.33. Web S1 eastbound structure span 4 drill locations

A leaking drain was noted with a moderate amount of cracking on web S2 (exterior web of box girder). Figure 6.34 shows the drainage duct with visible moisture staining.

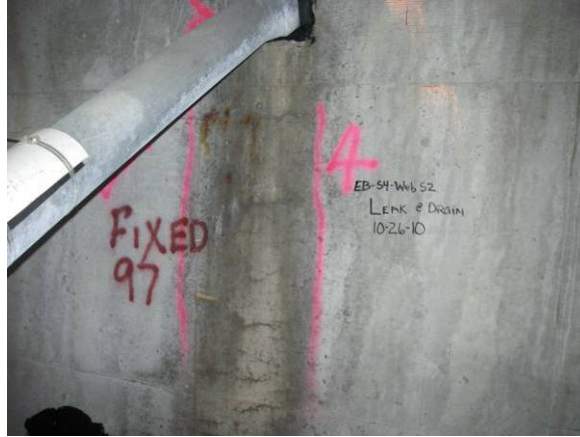

Figure 6.34. Drainage duct with moisture staining

To inspect the tendons in web S2, five drill holes were made. Despite the observation made of moisture staining and cracking in the web, no moisture or corrosion was present on the ducts, and the grout appeared to be solid and of good color. Figure 6.35 shows an elevation view of web S2 (exterior web of eastbound box girder) with the approximate locations highlighted.

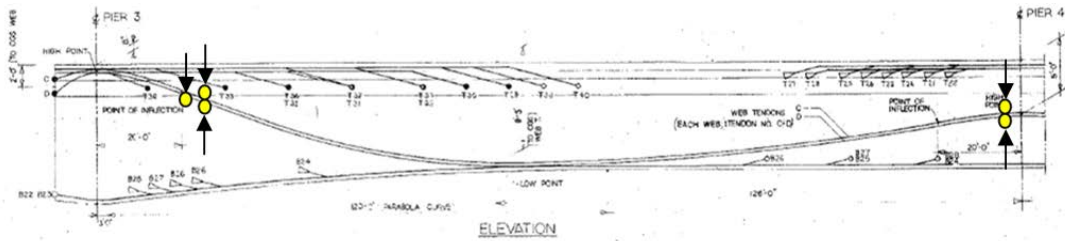

Figure 6.35. Web S2 eastbound structure span 4 drill locations

6.2.6 Span 4 Westbound Structure

The inspection of the westbound structure of span 4 included a visual inspection, as well as drilling into four duct locations in the webs N1 and N2. During the visual inspection, similar cracking was seen as in span three along the anchorage blisters for the tendons. The cracks along one of the anchorage blisters can be seen below in figure 6.36 (a black arrow is following one of the cracks).



Figure 6.36. Cracking along anchorage blister in span 4

Figure 6.37 shows the two drill locations highlighted in blue in web N1 (interior web of box girder). Drilled inspection holes into web N1 were found to have clean and dry ducts without moisture or voids. The grout in all the drill holes appeared to be solid and of good color.

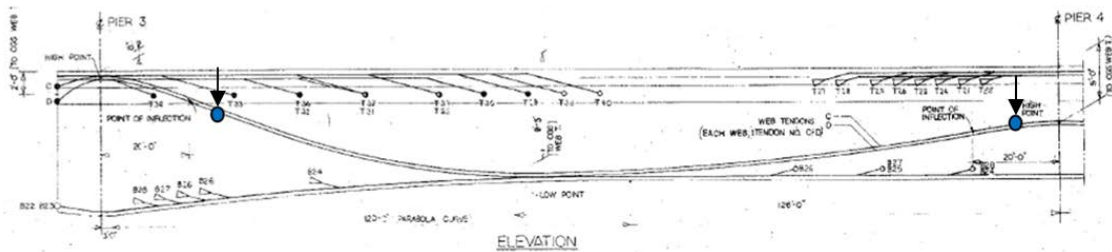

Figure 6.37. Web N1 westbound structure span 4 drill locations

Figure 6.38 shows the drill location highlighted in blue in web N2 (exterior web of box girder). Again grout appeared solid and of good color and no voids were detected.

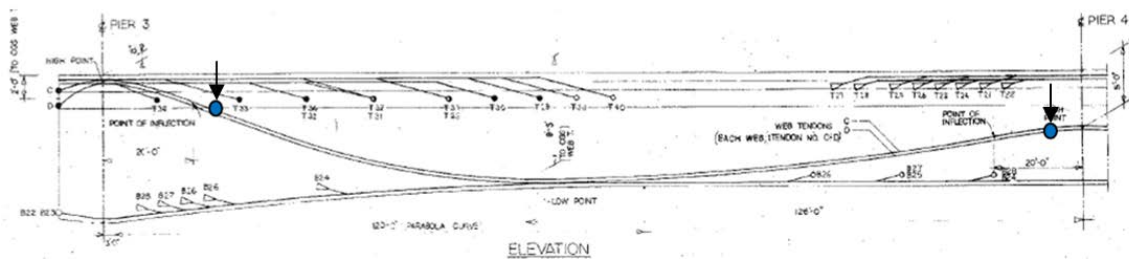

Figure 6.38. Web N2 westbound structure span 4 drill locations

6.2.7 Span 5 Eastbound and Westbound Structures

Inspection of span 5 composed of drilling inspection holes into several locations along the post-tensioned tendons within the webs of the box girders. Figure 6.39 shows an elevation view of

web S1 (interior web of eastbound box girder) and web N1 (exterior web of westbound box girder) of span 5.

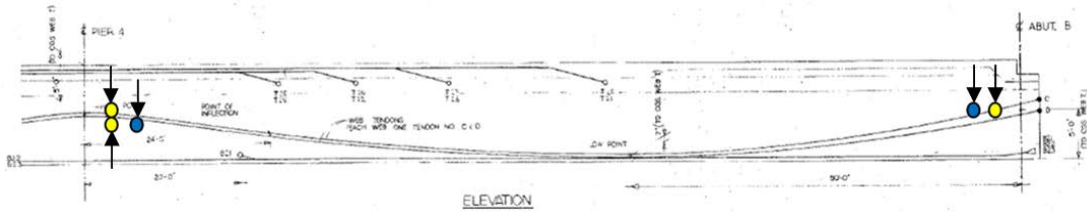

Figure 6.39. Span 5 web S1 and web N1 elevation view

Figure 6.40 shows the elevation view of web S2 (the exterior web of the eastbound box girder) and web N2 (exterior web of westbound box girder).

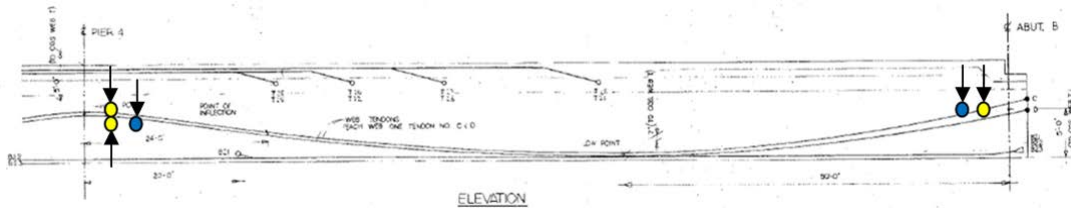

Figure 6.40. Span 5 web S2 and web N2 elevation view

All drilled inspection holes in span 5 were found to have clean and dry ducts with no voids detected, and no moisture seen. The grout in all the drill holes appeared to be solid and of good color.

6.3 Summary from Plymouth Avenue Inspection

The Plymouth Avenue Bridge has major corrosion in the bottom slab reinforcement including potentially complete corrosion of some of the post-tensioning tendons. The purpose of the investigation of this bridge as part of this project is in relation to the grout in the structure, so only selected areas of interest were chosen in the bottom slab tendons. The condition of many of the tendons was so poor that it was difficult to determine the quality of the remaining grout, but in ducts where the strand was intact enough to distinguish rust product from grout, the grout appeared to be in good shape. Higher chloride contents in the grout appear to be the result of moisture and salt ingress from the leaking drainage system. The surrounding concrete also had high chlorides, indicating that the salt was not isolated to the grout. Areas of high chloride had corresponding areas of high corrosion. The bottom slab has large areas of what appears to be a patching material over the base concrete. Many of these patches are delaminated and allowed direct ingress of moisture, chloride and oxygen to the tendons.

Spot checks were done on the box girder webs at high points and other areas of interest (such as areas with moisture present on the web surface). The web tendons are in good condition and appear to be fully grouted with a consistent (non-segregated) grout of the expected color. The grout used during the time frame of the construction of this bridge (early 1980's) would likely

have been a non-thixotropic water-cement grout. While the workmanship in many parts of the structure was poor and led to problems, the grouting appears to have been very good.

The Plymouth Avenue Bridge has major corrosion concerns that have caused it to be closed until repairs can be completed, but the grouting of the bridge appears to be of good quality.

Chapter 7 I-35 NB/SB Bridge ID #69818 in Duluth

Built in 1985, the I-35 northbound and southbound bridges span 2,736 feet (833.9 meters) for the northbound structure and 2,732 feet (832.7 meters) for the sister southbound structure. Across the over ½ mile (0.8 km) span the bridge crosses a variation of features including trunk highway I-35 NB, a pedestrian walk path (The Duluth Lakewalk), and The Saint Louis and Lake County Regional Railroad Authority tracks. The length of the bridge has superstructure elements of box girder sections, as well as I-beam sections. The post-tensioned portion of the structure is a multi-cell box girder with internal post-tensioned tendons. Each tendon includes up to 37 strands per duct in a varying parabolic profile internal in the webs. The width of the bridge varies along the length of the structure, and includes anywhere from 4 to 8 adjacent box girder sections. Figure 7.1 through 7.6 show aerial views of the I-35 Bridge with corresponding elevation views from the design drawings. Included in the figures are the labels of the structural units (SU) and the relationship of the design drawings to the aerial view.

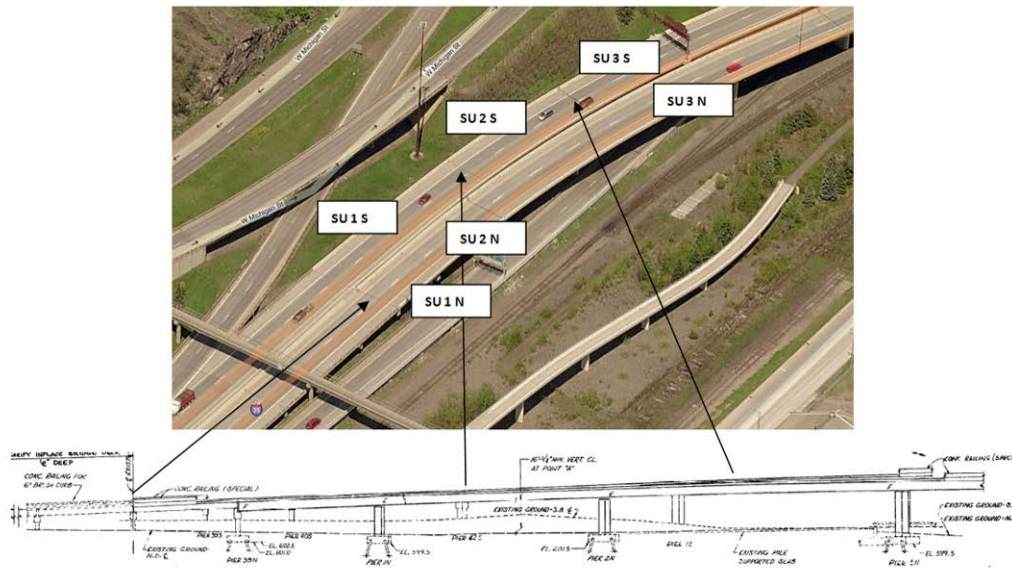

Figure 7.1. Pier 1N/1S to 3N/1S aerial view with corresponding design drawing (Bing, 2011)

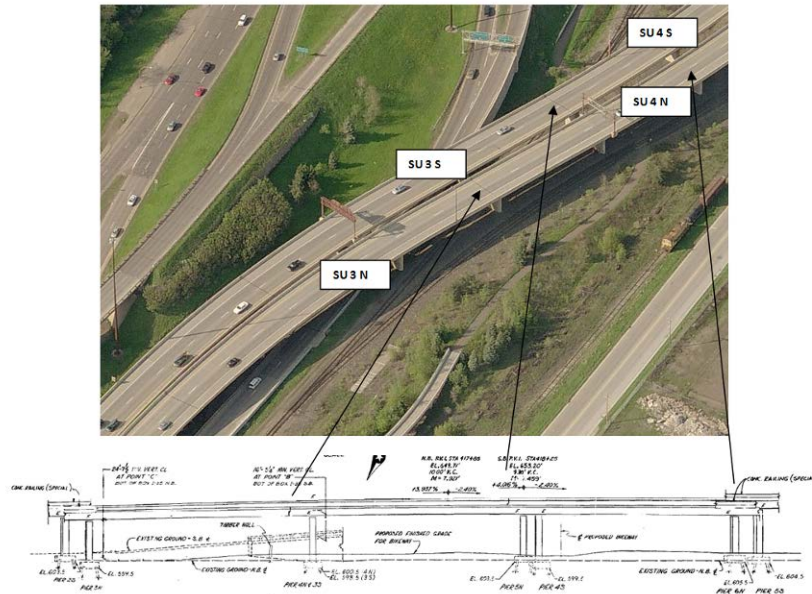

Figure 7.2. Pier 3N/2S to 6N/5S aerial view with corresponding design drawing (Bing, 2011)

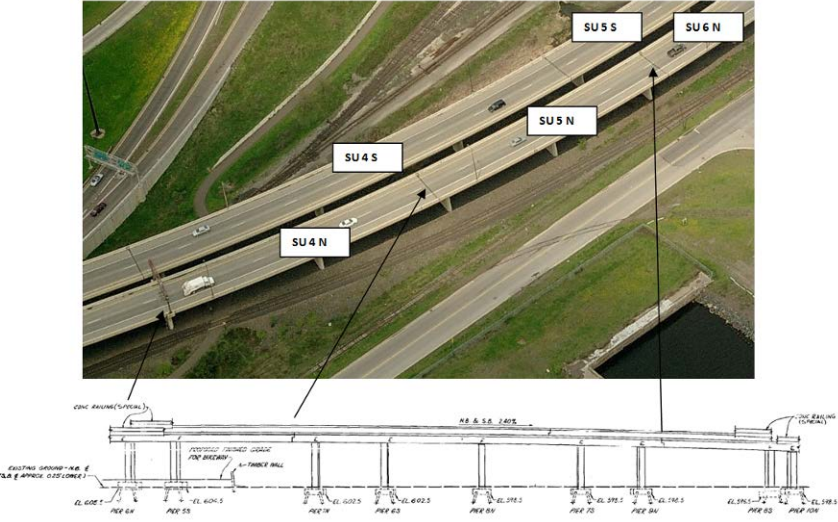

Figure 7.3. Pier 6N/5S to 10N/8S aerial view with corresponding design drawing (Bing, 2011)

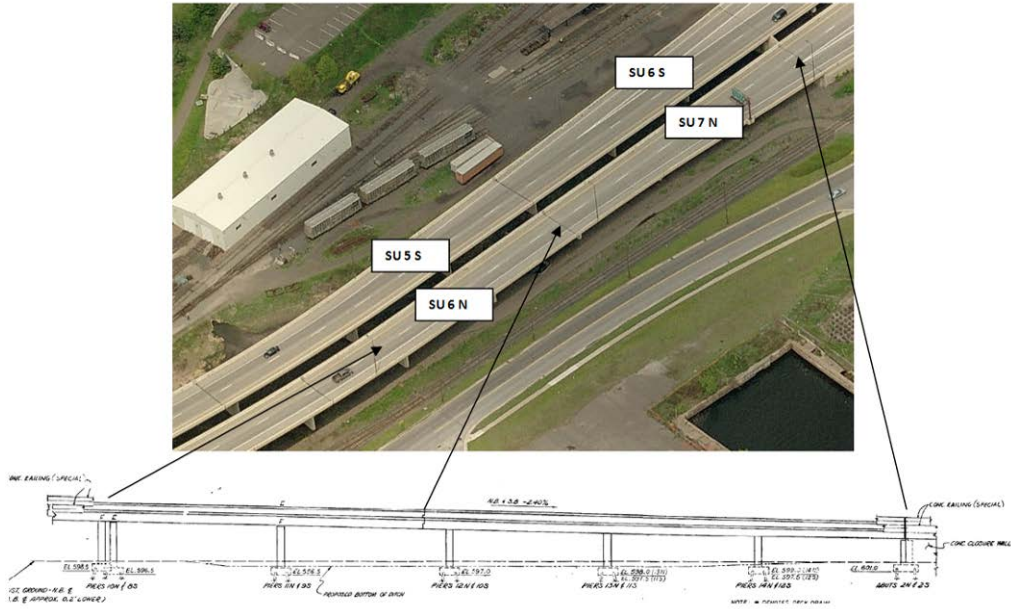

Figure 7.4. Pier 10N/8S to 14N/12S aerial view with corresponding design drawing (Bing, 2011)

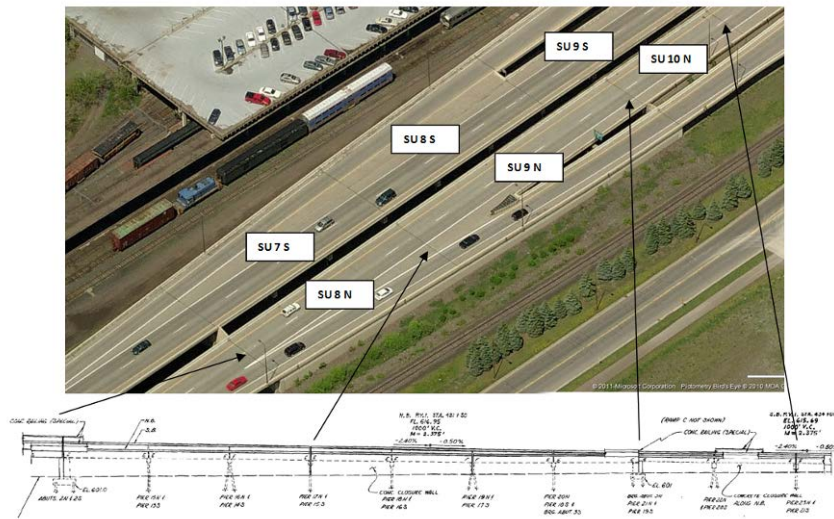

Figure 7.5. Pier 15N/13S to 23N/21S aerial view with corresponding design drawing (Bing, 2011)

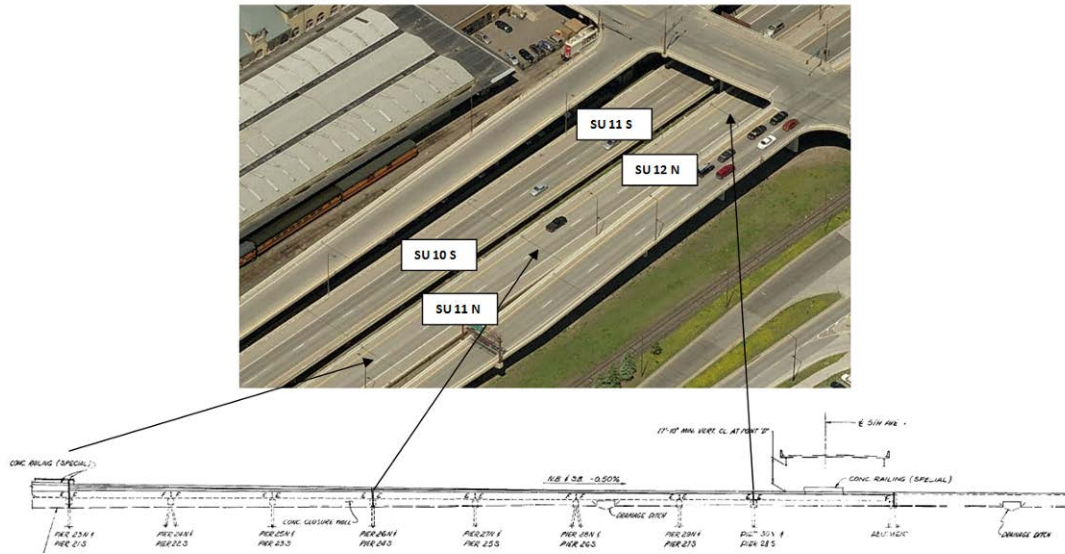

Figure 7.6. Pier 23N/21S to 30N/28S aerial view with corresponding design drawing (Bing, 2011)

7.1 Visual Inspection Performed by the University of Minnesota Duluth

During the annual inspection, web cracking was reported. A visual inspection was performed by UMD of the exterior of the structure, to further investigate the reported cracking, and to narrow the invasive inspection to a few select locations. Figure 7.7 shows an example of the cracking at the connection of two structural units. Also seen in the figure is rust staining and effluence emitting from one of the cracks.



Figure 7.7. Cracking at connection of structural units

Additional cracking was easily visible within the box girders of many of the sections. Figure 7.8 shows the interior of one of the end span box girders (the non-post-tensioned span) with diagonal cracks near a pier being evident. The cracks have been highlighted with pink chalk in the figure.



Figure 7.8. Diagonal cracking on interior of box girder

From the exterior of the bridge, rust staining was observed around the access hatches, as well as on the bottom slab. Figure 7.9 shows the rust staining observed near the access hatch of structural unit 6N. Also in this figure is a region (outlined in pink chalk) that has indications of honeycombing, as well as rust staining emitting. The area outlined produces a hollow sound during hammer sounding, indicating delamination in this section.



Figure 7.9. Access hatch for structural unit 6N

Because of the size of the structure, an inspection of each span was outside the scope of the project. A focus on structural unit 6N was selected due to several stress and corrosion problems that are most evident in this area of the structure. To further investigate this observation, a check of the post-tensioning ducts was inspected by VStructural, with a focus on anchor regions, and high points along the varying tendon profile where bleed would be most likely to occur.

7.2 Invasive Investigation Performed by VStructural

Inspection of the structure was performed on August 29, 2011 by VStructural and the UMD team. The investigation focused on inspection of post-tensioned tendons within the webs of span

1 and 2 of structural unit 6N of the northbound structure. In each of the webs of these spans, two tendons run along the length of the bridge with a varying profile to counteract the moment that is ensued by the loading on the structure. Each tendon is comprised of thirty one strands (seven wires per strand) in a metal duct. The locations inspected were selected due to signs of corrosion and delamination on the underside of the structure. Figure 7.10 shows the plan view of structural unit 6N including notation for the span, cell, and web labeling.

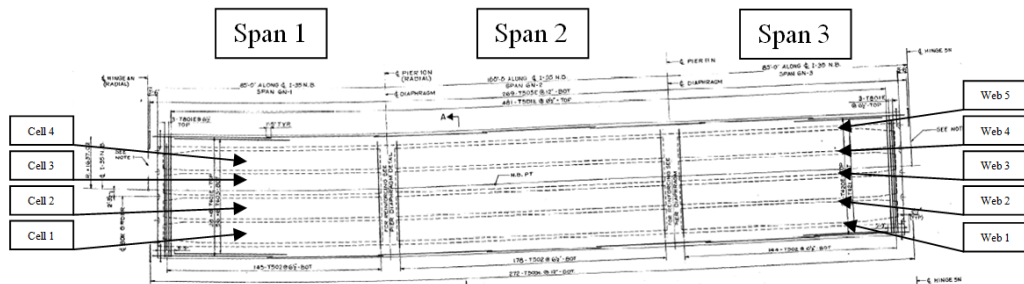

Figure 7.10. Plan view of structural unit 6N

7.2.1 Span 1 of Structural Unit 6N in Northbound Structure

The invasive inspection consisted of drilling into both ducts that are contained in web 2 and web 3 to inspect the internal tendons. Figure 7.11 shows a profile view of web 2 of span 1 of structural unit 6N. The tendon profile seen represents the center of gravity of the two contributing tendons (tendon 1 is the above the center of gravity, tendon 2 is below). Highlighted are the approximate locations that were drilled into to inspect post-tensioning system (orange represents inspections on tendon 1, green represents inspections on tendon 2).

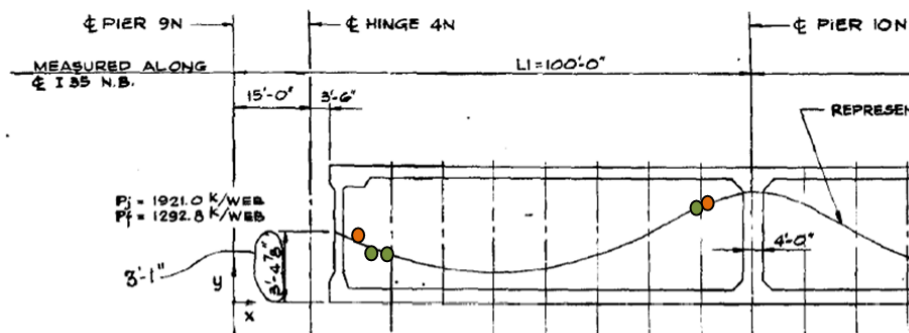

Figure 7.11. Span 1 web 2 structural unit 6N tendon profile view

Each opened duct showed the metal duct to be in good condition, free of any visible corrosion. The interior of the ducts showed solid grout of good color that filled the entire duct. As a representation of all the ducts drilled into in web 2 of span 1 in structural unit 6N, figure 7.12 shows the inspection hole. The location shown is the drilled hole into tendon 2 located 77.5 inches (1.97 meters) from pier 9N. Seen in the figure is the top of the duct and the grout contained in the conduit.

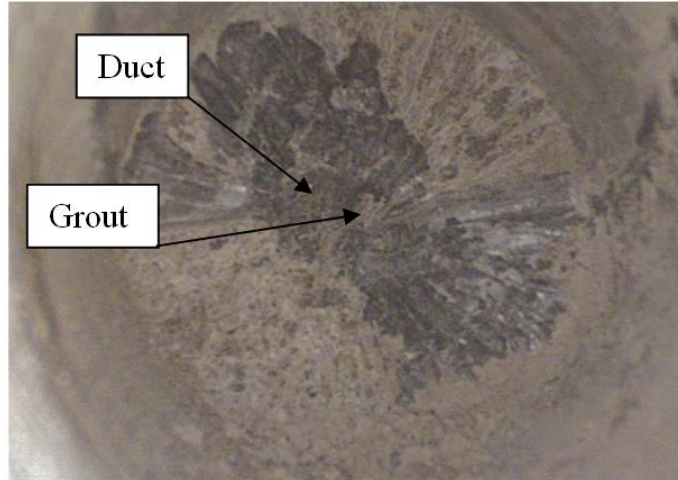

Figure 7.12. Tendon 2 view with borescope

Figure 7.13 shows the locations that were drilled into web 3. The tendon profile seen represents the center of gravity of the two contributing tendons (tendon 1 is the above the center of gravity, tendon 2 is below). Highlighted are the approximate locations that VSL drilled into to inspect post-tensioning system (orange represents inspections on tendon 1, green represents inspections on tendon 2).

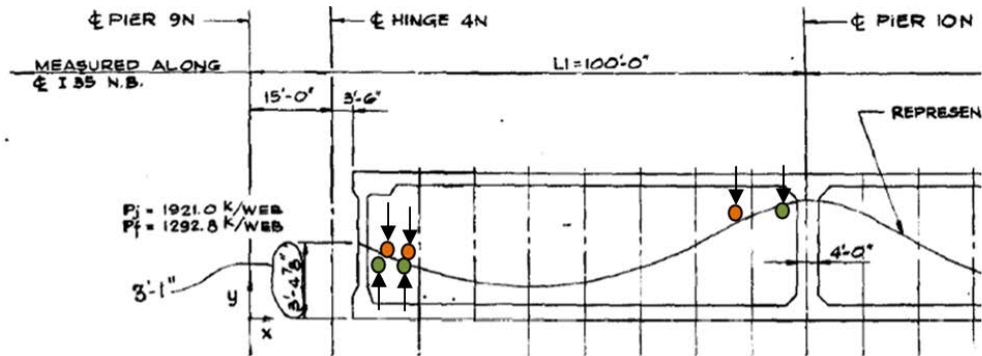

Figure 7.13. Span 1 web 3 structural unit 6N tendon profile view

Conditions of the tendons in web 3 were similar to that seen in tendon 2. Full ducts with good colored, solid grout were found in all inspection locations.

7.2.2 Span 2 of Structural Unit 6N in Northbound Structure

To continue inspection of a suspected trouble area, span 2 of structural unit 6N was investigated. Drilling locations were in webs 2, 3, 4, and 5. Figure 7.14 shows the tendon profile view of span 2. The locations that were drilled into were highpoints in the tendon profile. Figures 7.14 through 7.17 show the drill locations. Approximate locations that the post-tensioning system was inspected are highlighted (orange represents inspections on tendon 1, green represents inspections on tendon 2).

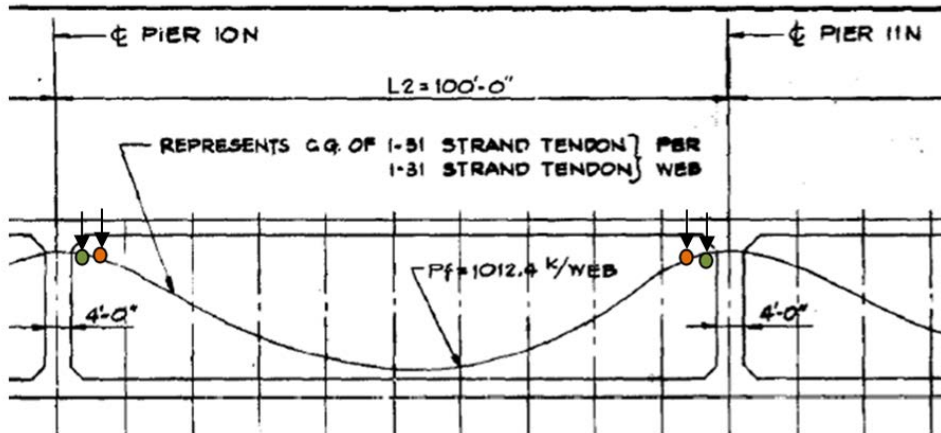

Figure 7.14. Span 2 web 2 structural unit 6N tendon profile view

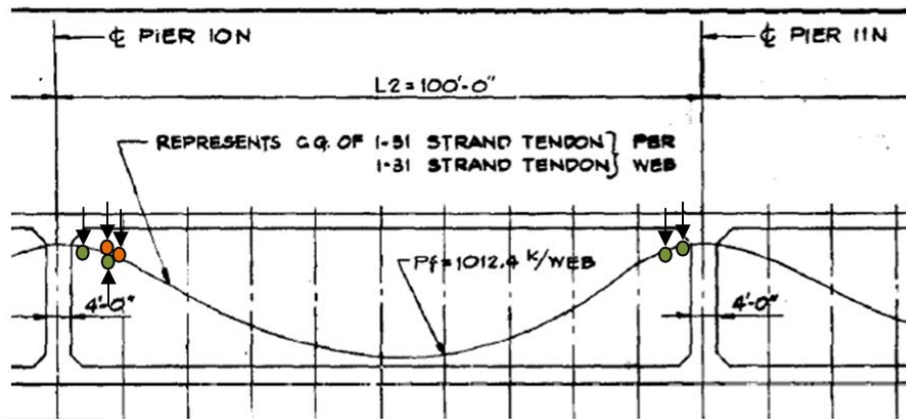

Figure 7.15. Span 2 web 3 structural unit 6N tendon profile view

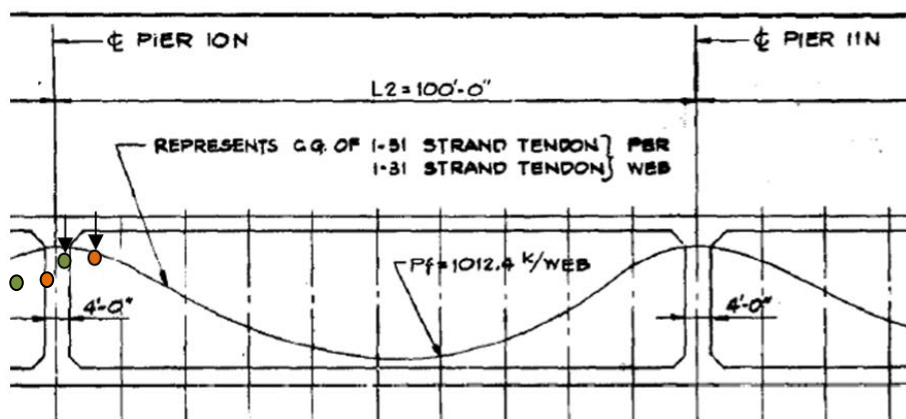

Figure 7.16. Span 2 web 4 structural unit 6N tendon profile view

Grout was found covering a large area on the bottom slab of cell 4 near at mid span. This was a possible indication of a grout leakage that may have left of void. Upon inspection of the ducts in web 4 and web 5, no voids were found.

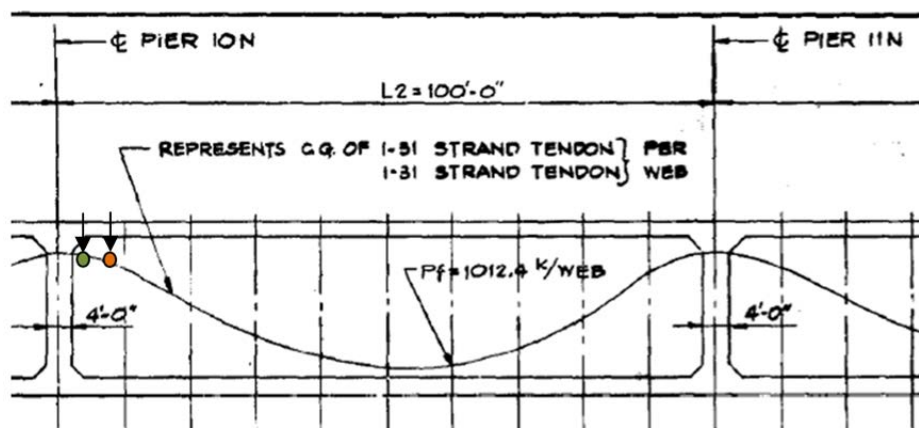

Figure 7.17. Span 2 web 5 structural unit 6N tendon profile view

7.3 Summary from Duluth Bridge 69818 N/S Inspection

In each of the post-tensioning ducts in span 2 of structural element 6N, good colored, solid grout was found. During the August inspection no problems were found directly related to the post-tensioning system or due to grouting. Although no problems were found in the structure, the sample size taken during the inspection was very limited, so it should not be used to conclude that no problems exist in the structure. A more widespread sample of points from along a larger number of spans would be preferable. At this time, preliminary indications from the spans tested show good quality grouting.

Indications are that the web cracking was present from the time of construction and that it is not related to the post-tensioning. These areas should be checked as part of a routine inspection of the bridge to ensure that they do not progress or begin to show signs of corrosion of the underlying reinforcement. The delaminated area should also be monitored. One hinge area on the structure also contained a large diagonal crack on the exterior web that should be monitoring during inspections.

It is also worth noting that the end span box girders do not contain post-tensioning (and this was verified by GPR). The cracking in the interior of these sections is noted and should be monitored as part of future inspections.

Chapter 8 US 10 EB Bridge, ID #02037E/W in Coon Rapids, MN

The twin eastbound and westbound structures were built in 1997, servicing eastbound and westbound traffic on US route 10. The bridges span over a bridge servicing Minnesota highway 610, as well as University Avenue (ground level). The structures are post-tensioned box girder sections containing 3 tendons per girder/web (as many as 27 strands per tendon). The webs of the box section are labeled and numbered as “girders” in the plans, so the term girder is used for consistency in this chapter. The eastbound structure spans 479 feet (146 meters) consisting of 3 spans with 5 girder lines (total of 15 tendons). The westbound structure spans 597 feet (182 meters) and consists of 4 spans with 5 girder lines (total of 15 tendons). The box girders have a height of 9 feet (2.7 meters) which results in the tendon profiles in the bridge having a significant vertical rise between the low points at mid span and high points at piers.

Discussion with MnDOT personnel indicated that some issues were encountered during construction in relation to the grouting procedure. It was reported by MnDOT officials that during construction of 02037 E, an area on girder 5 had a blockage during the fill of the grout into the tendon that did not allow for the grout to be pumped throughout the duct. A repair effort was made during construction to fill the remainder of the duct by pumping grout from the opposite end of the tendon. It was reported that the construction crew was not confident that tendon was completely filled with grout. Also reported by MnDOT was that a ready-mix truck was used to mix some of the grout for the tendons. The grout used in the bridge was a plain cement and water mix. Because of the mix being used and the process to mix it there is a high potential for excess bleed that would collect at high points. An extensive visual inspection, as well as invasive investigation was performed by VStructural and the UMD team on August 31 and September 1, 2011.

8.1 Invasive Investigation on Bridge #02037 E Performed by VStructural

The inspection of 02037 E was done exclusively on span 2 due to limited access availability at the time of the invasive inspection. The initial walk-through inspection revealed that there were several patches at the low points of the tendon profile (mid span) that showed signs of effluence, which is an indication sign of moisture in the patched areas. During the invasive inspection, an area of concrete was removed at the patch area at the low points of the tendon (near mid span) at two locations, as well as drilling into multiple locations at highpoints to check tendon conditions.

8.1.1 Exposure of Ducts at Low Points of Tendon Profile

Each girder consists of three draped tendons (tendon 1 refers to the top, tendon 2 refers to the middle, and tendon 3 refers to the bottom tendon). Figure 8.1 shows a plan view of the eastbound structure with the nomenclature of the spans, cells, and girder/webs labeled.

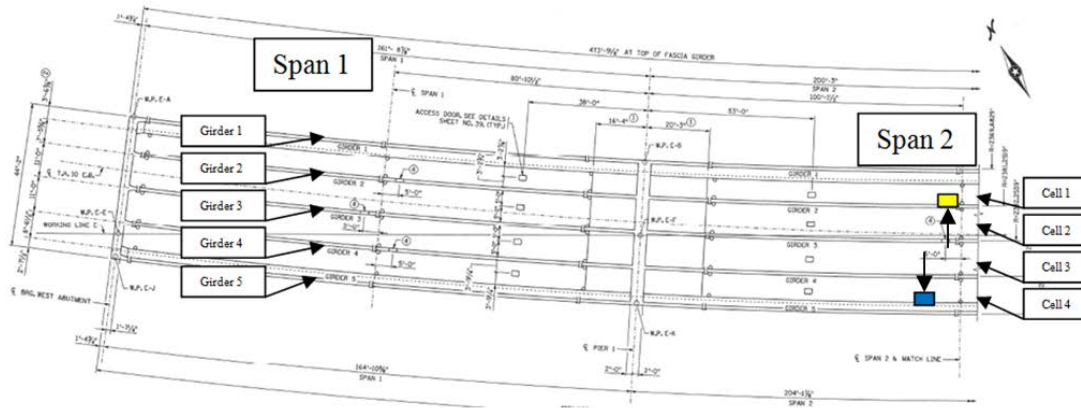

Figure 8.1. Plan view of span 1 and 2

The first location of interest was 90.5 feet (27.4 meters) from pier 1, in cell 1, within girder 2. Highlighted in figure 8.1 is the location of this inspection location (yellow highlight box). The location was a spot where the repair patchwork had effluence emitting, and cracking as shown in figure 8.2.

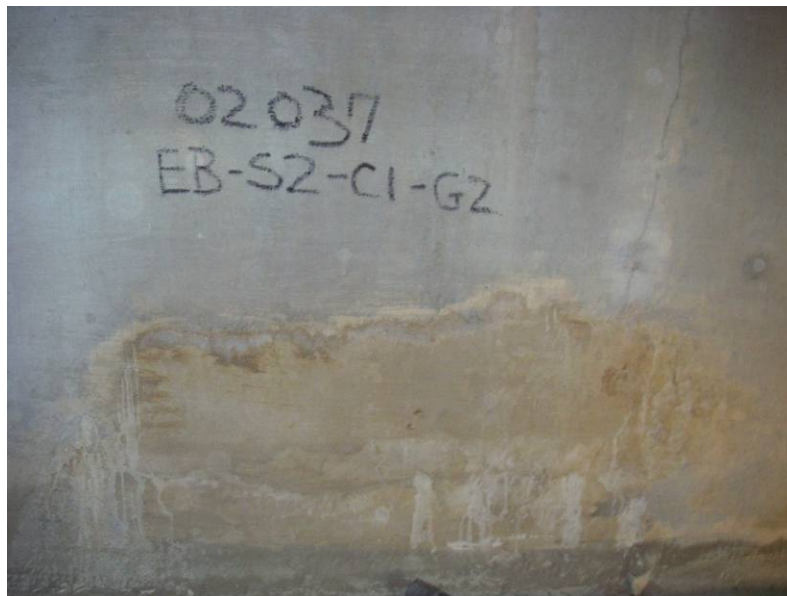

Figure 8.2. Discolored patchwork at mid span (Span 2)

The removal of the concrete cover revealed the ducts to be in good condition. Figure 8.3 shows the chipped out area with the duct exposed. The inspection hole made was approximately 8 by 15 inch area (20.3 by 38.1 centimeter area). Figure 8.4 shows the opening of the middle tendon (tendon 2). Seen in this figure is good colored, solid grout that completely filled the tendon.

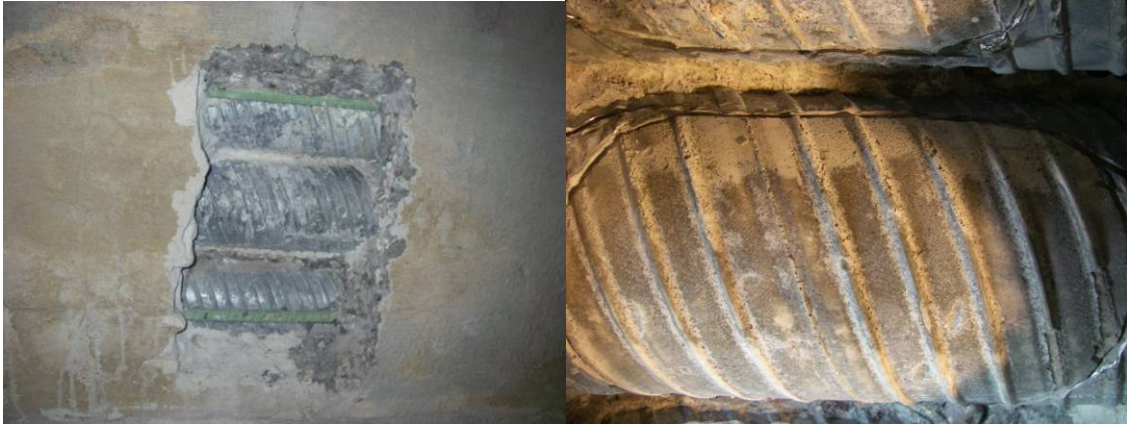

Figure 8.3. (Left) Cut out area exposing ducts

Figure 8.4. (Right) Opened tendon 2

Samples were taken from all three of the tendons for acid soluble chloride testing. Results are summarized in table 8.1. All chloride values are negligible indicating no chloride ingress into the tendon at this location.

Table 8.1. Chloride concentration of grout samples

Sample Location	Percent Chlorides by Weight of Grout
Tendon 1 (Top)	0.0059
Tendon 2 (Middle)	0.0044
Tendon 3(Bottom)	0.0042

The second location was located in cell 4 on girder 5 a distance of 78 feet (23.8 meters) from pier 1. This location is highlighted in figure 8.1 with a blue highlight box. Again the area was a location where a patch had effluence emitting from cracks. Figure 8.5 shows the location of interest during chipping of the patch material. Small tools were used once the duct was reached so that no damage was done to the tendon.



Figure 8.5. Removing cover at inspection area

The inspection hole was approximately a 9.75 by 19.75 in (24.8 by 50.2 cm) area as shown in figure 8.6. The figure shows that the ducts were in good condition with no visible corrosion (the windows have already been cut out exposing the interior of the duct).



Figure 8.6. Exposed ducts in girder 5 of span 2

With the exposure of the grout, a bleed trail could be seen running along the length of the duct. A close up of the bleed trail in tendon 2 is seen in figure 8.7. One of the strands of in each of the tendons was also exposed, and no corrosion was visible on any of the strands.



Figure 8.7. Bleed trail in tendon 2

Samples were taken from the middle and bottom tendons in girder 5 for acid soluble chloride testing. All values were negligible as shown in table 8.2.

Table 8.2. Chloride concentration of grout samples

Sample Location	Percent Chlorides by Weight of Grout
Tendon 2 (Middle)	0.0046
Tendon 3(Bottom)	0.0062

8.1.2 Highpoint of Tendon Profile Duct Inspection

During the inspection of 02037 E, eight duct locations within girder 5 were inspected. Each of the three tendons had their highpoints examined near pier 1 and pier 2. Figure 8.8 shows the elevation view of the tendon profile (the tendon line represents the path of the center of gravity of the three contributing tendons) with a highlight on the inspection locations (indicated by purple for tendon 1, green for tendon 2, and orange for tendon 3).

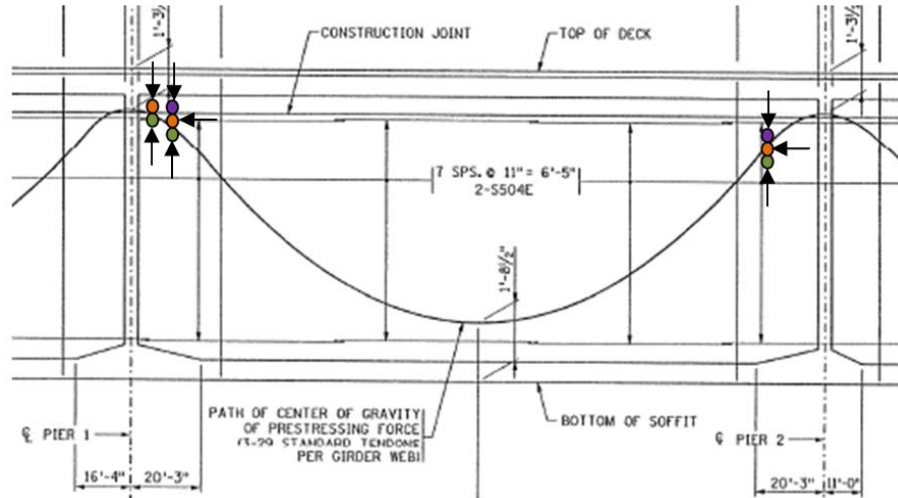

Figure 8.8. Span 2 tendon profile of girder 5

The inspection locations near pier 1 have similar results for each of the three tendons (one inspection point for tendon 1 and two inspection points for tendons 2 and 3). Each of these spot checks had a duct full of grout that was white in color and very chalky in consistency at the drill location. Figure 8.9 shows a photo taken with the borescope in the inspection hole of tendon 3, 101 in (256.5 cm) from pier 1. This inspection is a representation of the findings from all inspection holes near pier 1.



Figure 8.9. Boreoscope picture of drilled hole in girder 5 of span 2

Inspection holes of the three tendons towards pier 2 in span 2 had significant voids and some corrosion. Each of the duct inspections revealed large voids present, despite being 205.5 inches (522 centimeters) from the high point of the tendon at the pier. Tendon 1 had corrosion on top of the grout and duct with bubbles of corrosion product seen on the grout surface. The grout is a white and chalky indicating a poor quality material (high in water content and segregated). Despite the large void, there are no cables visible on top of the grout level in this tendon. Figure 8.10 shows a photo taken with the borescope within the duct (accessed through the inspection

holes) taken toward the high point (towards pier 2). The grout fills the duct only to approximately half capacity. Figure 8.11 shows the same location with the direction of the borescope to be pointed towards the low point (mid span).



Figure 8.10. Bore scope picture looking toward highpoint in tendon 1



Figure 8.11. Bore scope picture looking toward low point in tendon 1

The inspection into tendon 2 showed similar results. Again the void within the duct occupies half of the total area, and the grout that is present is a white and chalky in consistency. It is likely that closer to the highpoint there is a much larger void that exposes strands. Figure 8.12 shows a photo taken with the borescope within the duct (accessed through the inspection holes) taken toward the high point (towards pier 2). Figure 8.13 shows the same location with the direction of the borescope to be pointed towards the low point (mid span).



Figure 8.12. Boreoscope picture looking toward highpoint in tendon 2



Figure 8.13. Boreoscope picture looking toward low point in tendon 2

The inspection of tendon 3 showed similar results to that seen in the previous two tendons. Voids within the duct occupied a third to half of the total area, and the grout that is present is a white and chalky. Figure 8.14 shows a photo taken with the borescope within the duct (accessed through the inspection holes) taken toward the high point (towards pier 2). Figure 8.15 shows the same location with the direction pointed towards the low point (mid span).



Figure 8.14. Borescope picture looking toward highpoint in tendon 3



Figure 8.15. Borescope picture looking toward low point in tendon 3

8.2 Summary from Coon Rapids Bridge 02037 E Inspection

Structure 02027 E has indications of significant voids toward the high points in the structure. Some evidence of corrosion was also found. All repairs were sealed up with accommodations made for future access for investigation and repair. A full investigation of this structure continuing in a similar manner of accessing ducts at high points is recommended to determine areas with corrosion and voids. Remediation may include vacuum grouting the voided areas to establish a protective environment for the strand.

8.3 Invasive Investigation on Bridge #02037 W Performed by VStructural

The inspection of 02037 W was done on both spans 3 and 4 (limited to these spans due to accessibility, it would have required lane closures of under passing roadways to get into the box girders). The inspection of this structure involved a visual investigation of the two spans, as well as drilling into multiple locations at highpoints to check tendon conditions.

8.3.1 Span 3 Bridge 02037 W

Inspection of span 3 focused on girder 5 from cell 4, at six different locations (high points along the tendon profile). Figure 8.16 shows the elevation view in of the tendon profile in span 3 (the tendon line represents the path of the center of gravity of the three contributing tendons). The inspection locations are highlighted in the figure (indicated by purple for tendon 1, green for tendon 2, and orange for tendon 3).

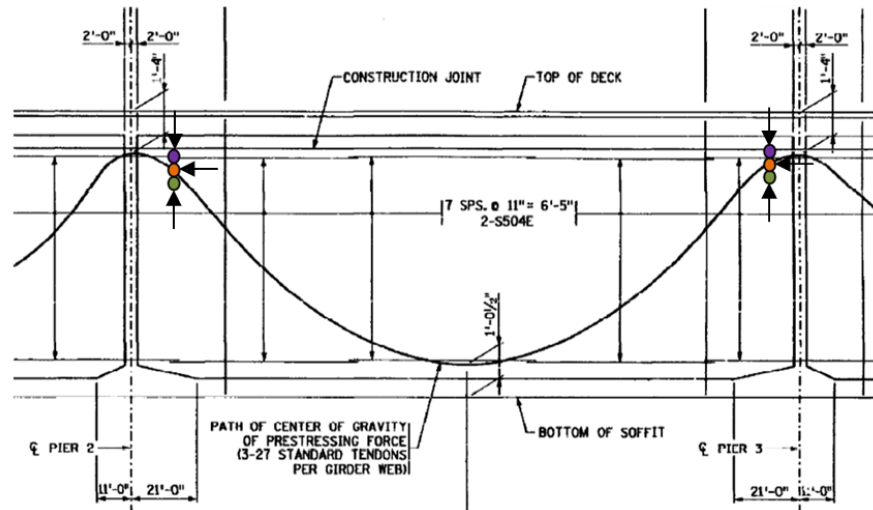

Figure 8.16. Span 3 tendon profile of girder 5

All of the inspection locations within span 3 have similar results for each of the three tendons. Each of these spot checks had a full duct of grout that was white in color and very chalky. Figure 8.17 shows a photo taken with the borescope into the inspection hole of tendon 1, 110 inches (279.4 centimeters) from pier 2. This inspection is a representation of the findings from all inspection holes in span 3.



Figure 8.17. Borescope picture of drilled hole in girder 5 of span 3

8.3.2 Span 4 Girder 4 Bridge 02037 W

Each of the three tendon highpoints were examined near pier 3 and by the east abutment. Figure 8.18 shows the elevation view of the tendon profile (the tendon line represents the path of the center of gravity of the three contributing tendons) with a highlight on the inspection locations into girder 4 (indicated by purple for tendon 1, green for tendon 2, and orange for tendon 3).

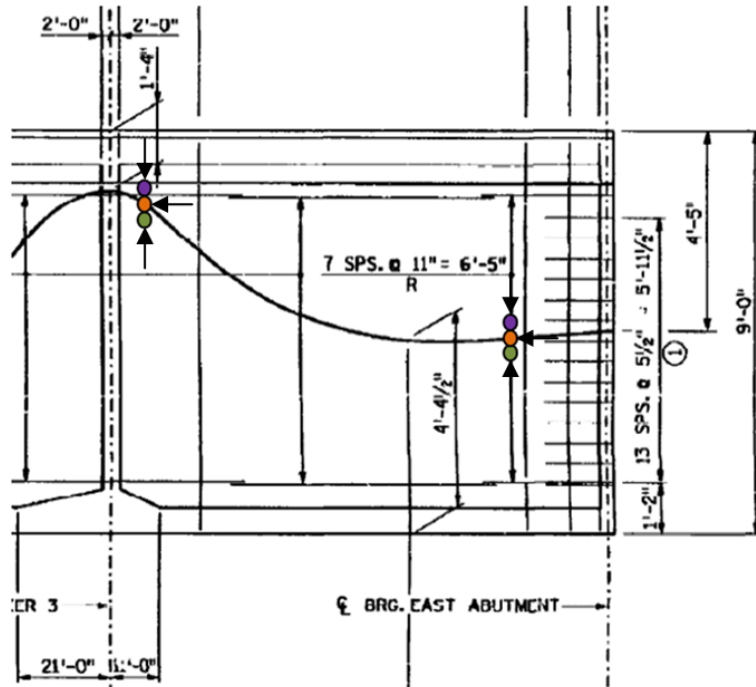

Figure 8.18. Span 4 tendon profile of girder 4

The inspection locations near the east abutment show similar results for each of the three tendons. Each of these spots had a duct full of grout that was white in color and very chalky. When a screwdriver was pushed into the grout, it easily sank into the chalky grout. The inspection hole into tendon 2 and 3 exposed one wire of the post-tensioned tendon, and no visible corrosion was seen. Figure 8.19 shows a photo taken with the borescope into the inspection hole of tendon 3, 15 inches (38.1 centimeters) from the east abutment. This inspection is a representation of the findings from all inspection holes near the east abutment in girder 4 of span 4.

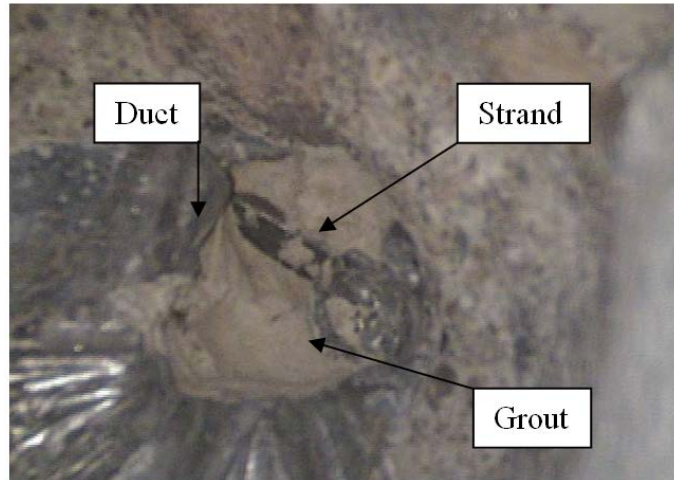

Figure 8.19. Borescope picture of drilled hole in girder 4 of span 4

The inspection holes located towards pier 3 for tendons 1 and 2 had similar results to those seen near the east abutment. A full duct of grout that was white in color and chalky was observed. When a screwdriver was pushed into the grout, it easily sank into the chalky grout. The inspection hole into tendon 3 revealed a large void in the duct. The duct was found to be approximately half to two thirds empty. The cables in the duct are exposed with what was classified as class 2 corrosion (Sason, 1995). Some of the cables are seen to have a slight film of grout covering them, others are completely unprotected. Figure 8.20 shows a picture from the borescope looking towards the highpoint (towards pier 3). This photo was taken 6 inches (15.2 centimeters) inside of the inspection hole.



Figure 8.20. Borescope picture looking toward highpoint in tendon 3, 6 inches (15.2 centimeters) inside of the inspection hole

To look further towards the highpoint of the duct the borescope proceeded to approximately 2 feet (60 centimeters) into the duct. At this point the duct is seen to be two thirds empty. Two cables have visible corrosion. Figure 8.21 shows a picture from the borescope looking towards the highpoint (towards pier 3). This photo was taken 24 inches (60 centimeters) inside of the

inspection hole. In this case, the grout level appears to have dropped after initially filling to a higher level. This indicates the potential for a leak or poor shutoff procedure of at a vent or inlet/outlet.



Figure 8.21. Boreoscope picture looking toward highpoint in tendon 3, 24 inches (61 centimeters) inside of the inspection hole

To investigate as close to the highpoint as possible, the borescope was threaded 3.5 feet (1.07 meters) into the duct. Figure 8.22 shows a picture from the borescope looking towards the highpoint (towards pier 3). This photo was taken 3.5 feet (1.07 meters) inside of the inspection hole. The void at this point is getting larger and the grout fill line is evident. The top half of the duct shows no signs of ever having had grout in it. There are two cables exposed that appear to have corrosion product on them.



Figure 8.22. Boreoscope picture looking toward highpoint in tendon 3, 3.5 feet (1.07 meters) inside of the inspection hole

Looking towards the low point (mid span) revealed similar results (although a somewhat higher grout level). The cables are covered in a light film of grout. Figure 8.23 shows a picture from

the borescope looking towards the low point (towards mid span). This photo was taken 6 inches (15.2 centimeters) inside of the inspection hole.



Figure 8.23. Boreoscope picture looking toward low point in tendon 3, 6 inches (15.2 centimeters) inside of the inspection hole

8.3.3 *Span 4 Girder 5 Bridge 02037 W*

Each of the three tendons in girder 5 had their highpoints examined near pier 3 and by the east abutment. Figure 8.24 shows the elevation view of the tendon profile (the tendon line represents the path of the center of gravity of the three contributing tendons) with a highlight on the inspection locations into girder 4 (indicated by purple for tendon 1, green for tendon 2, and orange for tendon 3).

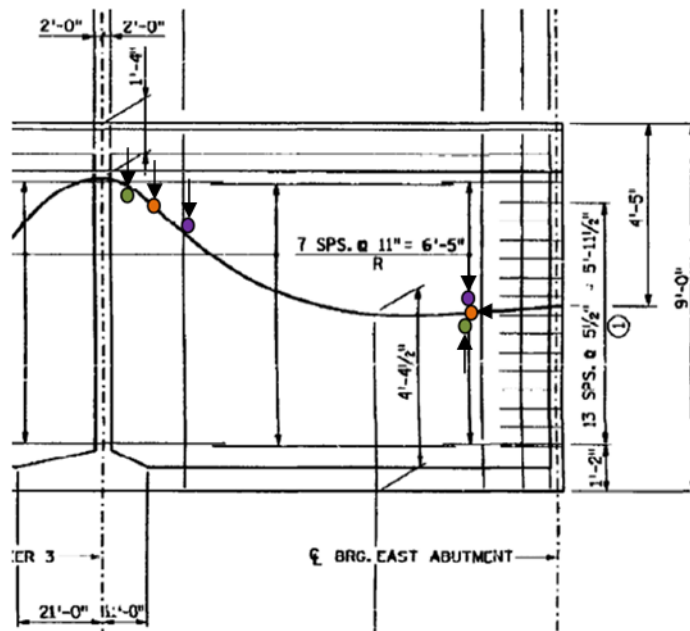

Figure 8.24. Span 4 tendon profile of girder 5

The inspection locations near the east abutment gave similar results for each of the three tendons. Found in each of these spot checks was a duct full (all strands have cover) of grout that was white in color and very chalky. One strand was exposed in the inspection hole in tendon 3 and no visible corrosion was seen on the strand. Figure 8.25 shows a photo taken with the borescope into the inspection hole of tendon 3, 17 inches (43.2 centimeters) from the east abutment. This inspection is a representation of the findings from all inspection holes near the east abutment in girder 5 of span 4.

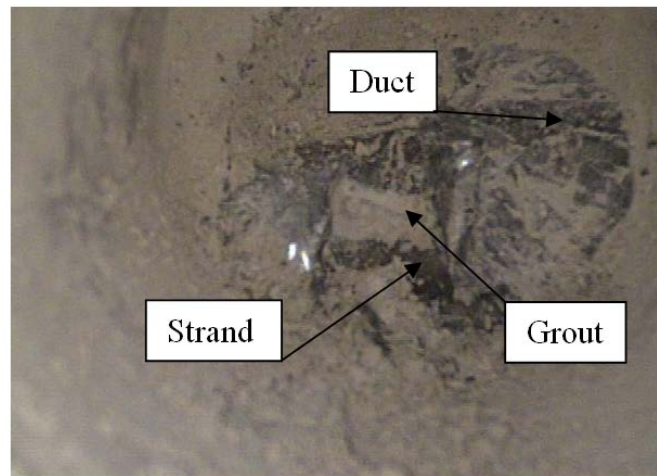

Figure 8.25. Borescope picture of drilled hole in girder 5 of span 4

The inspection holes located towards pier 3 for tendons 1 and 2 had similar results to those seen near the east abutment. A full duct of grout that was white in color and chalky was observed. The inspection hole into tendon 3 revealed a large amount of corrosion on the duct as well as a void in the duct estimated to be 10 feet (3.05 meters) in length. The duct was found to be approximately half to two thirds empty. Figure 8.26 shows a picture from the borescope looking towards the highpoint (towards pier 3). This photo was taken 6 inches (15.2 centimeters) inside of the inspection hole. No cables are exposed, but a significant corrosion is seen on the duct.



Figure 8.26. Borescope picture looking toward highpoint in tendon 3, 6 inches (15.2 centimeters) inside of the inspection hole

To look further towards the highpoint of the duct the borescope was threaded approximately 1.5 feet (45.7 centimeters) into the duct. At this point white chalky grout is seen, and heavy duct corrosion is visible. Still no cables are exposed. Figure 8.27 is a picture from the borescope looking towards the highpoint (towards pier 3). This photo was taken 18 inches (45.7 centimeters) inside of the inspection hole.



Figure 8.27. Borescope picture looking toward highpoint in tendon 3, 18 inches (45.7 centimeters) inside of the inspection hole

To investigate as close to the highpoint as possible, the borescope threaded 5.5 feet (1.68 meters) into the duct. Figure 8.28 shows a picture from the borescope looking towards the highpoint (towards pier 3). This photo was taken 5.5 feet (1.68 meters) inside of the inspection hole. The void at this point still appears to be at half of the duct. No cables are exposed, but heavy duct corrosion is present.



Figure 8.28. Boreoscope picture looking toward highpoint in tendon 3, 5.5 feet (1.68 meters) inside of the inspection hole

Looking towards the low point (mid span) revealed similar results. No cables are exposed, but white chalky grout is seen with corrosion on the duct. Figure 8.29 shows a picture from the borescope looking towards the low point (towards mid span). This photo was taken 46 inches (116.8 centimeters) inside of the inspection hole.



Figure 8.29. Boreoscope picture looking toward low point in tendon 3, 46 inches (116.8 centimeters) inside of the inspection hole

8.4 Summary from Coon Rapids Bridge 02037 W Inspection

Significant voiding is present in structure 02037 W along with duct and strand corrosion. Evidence of leakage or back flow is present along with poor quality grout. As with structure 02027, a thorough invasive inspection is recommended to locate voids and corrosion so that repairs can be made. The presence of duct corrosion indicates an adequate presence of moisture and oxygen in the duct that may lead to additional strand corrosion if not remediated.

Chapter 9 Blatnick I-535 Bridge ID # 9030 in Duluth

Connecting Duluth Minnesota to Superior Wisconsin, the Blatnick I-535 Bridge spans 7,980 feet (2,432 meters) over multiple city roads, railroad tracks, and the St. Louis River. The structure is comprised of both concrete elements (at approaches to mid span), as well as a steel truss (at the main span). The Blatnick was constructed in 1992, and the only component of the bridge that has been post-tensioned are the pier caps.

During construction of the pier caps, shrinkage cracking was prevalent around the anchorage unit. These cracks were repaired after construction was completed, but during the annual inspection of the bridge, cracking was still reported. No indications of post-tensioning problems were noted during inspection.

9.1 Visual Inspection

University of Minnesota Duluth team performed an inspection in conjunction with a MnDOT critical fracture inspection team that was already on site to further investigate the cracking on the PT caps on July 26th, 2011. Using a snooper truck, several of the PT caps were closely inspected and bursting cracking around anchorages was observed. Although it was noted that the cracking occurred during construction, the cracks continued through the patching. Seen below in figure 9.1 is an end view of the pier cap with cracks seen around the anchorage system. Moisture is present in the cracks, particularly those around the anchorage area.



Figure 9.1. PT cap on Blatnick Bridge pier

Seen in figure 9.2 below, a side view of the same pier is seen. Cracking that follows the square of the pourback area is seen at the location of the anchorage cover, as well as cracking extending along where the post-tensioned tendon runs in the longitudinal direction.



Figure 9.2. Cracking extending from anchorage on PT pier cap

Figure 9.3 shows the same pier towards mid span. In this photograph, vertical cracks are seen to extend the entire height of the pier, as well as a longitudinal crack along the tendon profile.



Figure 9.3. Vertical and horizontal cracking in pier

The cracks seen in figures 9.1, 9.2, and 9.3 are typical of each of the piers in the structure. Figure 9.4 shows a longitudinal view of the pier with numerous cracks running vertically on the pier (a yellow highlight has been added to make the cracks more visible in the photo).



Figure 9.4. Longitudinal view of typical post-tensioned pier

9.2 Summary and Recommendations

The pier caps should be inspected thoroughly including an invasive inspection at one of the anchorage ends. It is important to determine if the moisture present at the cracks is just surface moisture remaining in the cracked areas under humid conditions or if the moisture is trapped near the anchorage (or in a worst case scenario, the moisture is coming from the anchorage).

Chapter 10 US 10 EB on Ramp Bridge ID #02034 in Coon Rapids

The structure serves as an entrance ramp to US 10 going eastbound in Coon Rapids. Built in 1996, Bridge 02034 spans 407 feet (124 meters) over an exit to MN 47 southbound. The bridge is a post-tensioned box girder section containing 4 cells.

During the annual inspection performed on the structure, significant deck cracking was reported as well as cracking inside of the box girder that was significant enough to require an epoxy fill to be used for a repair patch. These cracks indicate possible post-tensioning issues, and possible corrosion taking place. No indications were made of specific problems to the PT boxes. The tendons have a parabolic drape profile of little vertical rise, but the particular layout of the structure makes the tendons susceptible to bleed problems at high points of the tendons, as well as near anchorages.

10.1 Visual Investigation Performed by VStructural

In coordination with MnDOT, the team determined that the time allotted for invasive inspections by the VStructural team was better spent staying with the I-10 structure described in Chapter 8. The team visited the site of the #02034 structure for a visual evaluation. Only superstructure plans were available for this structure. The structure was chosen for evaluation based on the reports of cracking in the superstructure. Visual inspection of the exterior of the box girders did not indicate problems, but an internal inspection is needed.

From ground level, it was observed that the straddle bent has cracking and efflorescence emitting from cracks as shown in figure 10.1. While plans were not available, the bent appears to have a pourback and thus is likely to be post-tensioned.



Figure 10.1. Pier with cracking and efflorescence

Figure 10.2 shows cracks running along the straddle bent in the longitudinal direction. The cracks (highlighted in yellow) may be following the tendon profile along the straddle bent. The pourback region is visible from the side in this figure.



Figure 10.2. Cracking along straddle bent

10.2 Summary and Recommendations

The interior of the superstructure box girders should be inspected with a focus on the problem areas indicated in past inspection reports. The straddle bent cap cracking should also be investigated with a comparison of the cracking to the tendon profile in the plans (or by locating the tendons with GPR). Locations near the anchor should be invasively inspected with a borescope to determine the condition of the tendon and grout.

Chapter 11 Inspection Guide for Post-Tensioned Bridges

The MnDOT bridge inventory contains post-tensioned bridges ranging in age from the 1970's to the present. The standard bridge inspections should include a specific set of checks that are done for all PT bridges in addition to the standard inspection. A recommended procedure is given below by PT bridge component type. If conditions require significant invasive inspection or repair, a contractor experienced specifically in PT structures is preferable since there are many variables in PT bridge types. Figures are not included in this procedure outline, so the reader should refer back to the main body of the report for visual reference. These figures can be used during training for inspectors. Smart flags (or other flag to notify of PT problems) should be developed specific to PT structures.

11.1 General Evaluation for All PT Members

1. external visual inspection (yearly with standard inspection)
 - a. note any cracking or corrosion that could be related to PT or that could cause a problem for the PT (tendon profile information / plans need to be reviewed and available on site during the inspection)
 - i. anchor region cracking (if accessible) including cracking around pourback areas
 1. identify as cracking, moisture and/or corrosion product
 - ii. cracking running along tendon profile
 1. identify as cracking, moisture and/or corrosion product
 - iii. moisture or drainage problems that may interact with tendons
 2. Patching
 - a. The patching procedure for filling voids and replacing the caps, pourback, etc should be in place **before** drilling into the duct. Drilling into the duct provides access to moisture and oxygen that can drive corrosion even if none was present when the duct was opened.

11.2 Specifics for Box Girder Superstructure (Internal Inspection of Internal or External Tendons)

1. Internal visual inspection (every 3 years or if indicated by results of external visual inspection)
 - a. Internal tendons
 - i. Follow the same procedure as for external visual inspection to find cracks, moisture, and corrosion product
 - ii. Identify drainage or leakage problems that would result in the interior of the box collecting moisture, particularly chloride laden moisture from deicing salt runoff; bottom slab tendons can be particularly susceptible when moisture collects in the box
 - iii. Look for any areas that would indicate patching and carefully evaluate these areas for moisture, cracking, or separation from the base material
 - b. External tendons
 - i. Check for cracking along the length of duct
 - ii. Check deviators and anchor areas for good seal

- iii. Look for any indications of tendon movement at anchors or deviators that might indicate release of prestress (broken strand)
 - iv. Indicate any moisture, drainage, or leakage problems, particularly chloride laden moisture from deicing salt runoff
 - v. Tap tendons with a hammer to identify potential voids (hollow sound); do not put a hole in the duct unless it can be immediately patched after investigation
2. Invasive inspection (see invasive inspection recommendations section 12.2 for recommendations on which bridges to have inspected)
- a. Identify areas of interest either through results of visual inspection or by determining a statistically relevant sample to spot check the condition of the tendons throughout the structure
 - b. Identify tendon location along its length with ground penetrating radar (GPR); trial and error drilling may be used, but it causes additional damage to the structure and is time/labor consuming
 - c. Drill into location of interest using caution when the level of the duct is reached. It is preferable to be in the upper half of the duct to look for voids.
 - i. If the bit punches through the duct, then the grout is either of poor quality or the duct has a void. Use a borescope to examine the void and photograph the conditions. In the case of a long void, the borescope can be threaded back to get an estimate of the void length and condition.
 - ii. If the bit indents the duct but meets resistance, the tendon is typically full or has only small voids; the duct can be pierced with the drill tip to see some of the underlying grout. Use a borescope for inspection and photos.
 - iii. Samples of surrounding concrete may be taken for chloride testing if there is concern of chloride ingress to the duct from the concrete surface
 - iv. Patch the area immediately
 - 1. If no problems are found, patch and fill the drill hole with a high quality patch material
 - 2. If a void or corrosion is found, insert an inlet/valve that can be used for future evaluation with the borescope and then future re-grouting if needed
 - d. A larger inspection hole may be warranted if tendon corrosion is found or if a larger area must be investigated along the duct.
 - i. Demarcate the area of the cut with a shallow saw cut
 - ii. Chip the concrete away to close to the level of the duct (using hand chipping or smaller tools near the level of the duct so that it is not damaged)
 - iii. Evaluate the duct condition, then cut a section of the duct with a small rotary tool to reveal the grout
 - iv. Evaluate the grout condition then chip out a small area to inspect the strand; retain the chipped grout for chloride testing (collect the grout samples directly while chipping so they are not contaminated by other surfaces)
 - v. Patch the area immediately

11.3 Specifics for End Anchors (Girders, Slabs, Caps or Straddle Bents)

1. If the anchor head is accessible, chip out the pourback to reveal the strand and anchor head. If a cap is in place, remove the cap to evaluate the fill of grout under the cap.
 - a. Use a flexible drill bit to remove grout from the access port or through an empty wedge hole in the anchorage. Sometimes the access port will be filled with grout, but a void may exist behind the anchor head.
 - b. If a void exists, use the borescope to evaluate and photograph the extent of the void and the tendon condition
 - c. If corrosion is found, take samples of the pourback material and grout material for chloride evaluation.
 - d. Patch immediately

Chapter 12 Conclusions and Recommendations

Recommendations for inspection and follow-up are given in the chapters specific to the bridges. The conclusions directly related to PT for the 3 bridges that underwent invasive inspection are summarized below.

12.1 Plymouth Ave (#27611)

- Grouting appears to be good for all areas checked
- Web tendons all were well-grouted and no corrosion was found
- Severe corrosion in some of the bottom slab tendons; grouting appeared to be good quality, but ingress of chlorides was evident in the grout where significant corrosion was found in the strand
- Ingress of chlorides appears to be from chloride laden water that was ponded in the box girder due to poor drainage (accentuated by poor patching in the bottom slab that allowed easy ingress of chlorides and moisture to the duct level); the chlorides reached the grout and strand after corroding through the duct
- This structure is closed and will be remediated before reopening

12.2 I-35 NB/SB (#69818 N/S)

- No grouting problems or tendon corrosion found in any of the spot checks
- A more thorough inspection is recommended to provide a more representative sample of data from this long structure since it is typical of many box girder bridges of this type in Minnesota built prior to the use of thixotropic grouts

12.3 US 10 EB (#02037 E/W)

- The spot checks of this structure indicated
 - Significant voids
 - Extensive chalky (high water content, poor quality) grout
 - Strand and duct corrosion in a few locations
 - Numerous patched areas in the box that provide a potential weak point for ingress of moisture and oxygen
- Chlorides do not appear to be a problem at this time since the drainage system is working well and there are no bottom slab tendons
- Moisture and oxygen are getting access to the ducts with voids resulting in corrosion of both strand and the interior of the duct
- A full investigation of this structure continuing in a similar manner of accessing ducts at high points is recommended to determine areas with corrosion and voids
- Remediation may include vacuum grouting the voided areas to establish a protective environment for the strand

12.4 Invasive Inspection Recommendation

It is recommended that all post-tensioned bridges built prior to 2003 in the MnDOT bridge inventory be inspected for voids in the tendons. In the event a complete inspection of the bridge

inventory cannot be performed, it is recommended to follow the inspection recommendation rating (as seen in chapter 4 for individual bridge inspection recommendation ranging from 1-10) for priority of which bridges to inspect. In order of the assigned inspection recommendation rating, either a batch inspection or a single sampling plan should be followed depending on the condition of the bridge.

VSL has referenced “Sampling Procedures and Tables for Inspection by Attributes” developed by American National Standard Institute ANSI/ASQC Z1.4 to determine the sample size and procedure on several of their past projects (ANSI/ASQC, 1993). The purpose of this publication is to establish sampling plans and procedures for inspection by attributes. Inspection by attributes is inspection where either the unit of product is classified simply as conforming or nonconforming, or the number of nonconformities in the unit of products is counted, with respect to a given requirement or set of requirements. Using this system, a sample size can be assigned to a given project. Two separate categories have been created for the number of inspection points to be considered, a look at the entire group, and a single sampling plan.

For inspecting post-tensioned structures, the entire group (batch) would be all of the locations of interest in the structure. Knowledge of previous construction practices is used to determine the locations which make up the batch. For instance, if the goal of the inspection is to locate grout voids, the batch might consist of all high points and tendon anchorages in the structure. The sample would be the quantity of those locations, selected randomly, to be inspected. In the event that problems have been indicated for a structure in relation to the post-tensioning system, it is recommended that the entire group (batch) be inspected in the structure.

The Single Sampling Plan (SSP) is recommended for determination of acceptability. The number of sample units inspected is equal to the sample size given by the plan. If the number of nonconforming units found in the sample is equal to or less than the acceptance number, the lot of batch shall be considered acceptable. If the number of conforming units is equal to or greater than the rejection number, the lot or batch shall be considered not acceptable. The inspection recommendation can serve as a priority rating system to follow for which bridge to inspect using the single sampling plan. It is advised that all bridges receiving an inspection recommendation of 8 and above in this report have a minimum of a SSP conducted to insure structural integrity and to evaluate potential problems. Bridges receiving this rating or higher are susceptible to the potential problems mentioned in this document. Bridges receiving a recommendation of a 7 should at a minimum have a thorough visual inspection performed with a focus on the issues mentioned in the discussion section in the appendix (specific discussion to each individual bridge). Seen in table 12.1 is the complete list of PT bridges in order of recommended inspection rating (10 being the highest).

Table 12.1. Bridges in order of recommended inspection

Bridge #	Facility	Feature	Year Built	Inspection Recommendation
27611	PLYMOUTH AVE	MISSISSIPPI RIVER	1980	10
27262	LRT	TH 55, RAMP, & LAKE ST	2002	10
02037E	US 10 EB	University Ave & MN 610	1997	9
02037W	US 10 WB	University Ave & MN 610	1997	9
9350	I-94	Mississippi R , Ramp	1994	9
27719	LYNDALE AVE N	SHINGLE CREEK	1982	8
69818N	I 35 NB	SL&LC RR & TH 194 NB	1985	8
69818S	I 35 SB	SL&LC RR & TH 194 NB	1985	8
02034	US 10 EB On Ramp	MN 47 SB	1996	8
9030	Blatnick (I-535)	St. Louis R, RR, Street	1992	8
27194	TH 5 EB	US 212 & WB on ramp	1998	8
27217	TH 252 NB on ramp	TH 610	1998	8
27593	34TH AVE S	MINNEHAHA CREEK	1974	7
27264	LRT	TH 55, 62 & RAMP	2003	7
82856	TH 494 WB	Mississippi R & UP RR	2003	7
52009	TH 860D	US 169	1985	7
70037	US 169 EB	MSAS 131	1994	7
70038	US 169 WB	MSAS 131	1994	7
62555A	MSAS 235(NB WAB S)	MISS R & RR & STR'S	1996	6
62555B	MSAS 235(SB WAB S)	MISS R & RR & STR'S	1996	6
27218	TH 252 SB	TH 610	1998	6
27219	TH 252 SB	TH 610 WB on ramp	1998	6
27220	PEDESTRIAN	TH 610	1998	6
27581	FREEWAY BLVD	SHINGLE CREEK	1974	5
02044	Pedestrian	US 10	1997	5
27A58	CSAH 101	Grays Bay Channel	2000	5
27622	SB SHIN CRK P(109)	SHINGLE CREEK	1980	4
27717	I 94	Shingle Creek	1980	4
27904	I 94 WB on ramp	Shingle Creek	1980	4
27810	I 94	PED PATH	1982	4
27547	CHICAGO AVE S	MINNEHAHA CREEK	1970	4
94174	BLDG(PARKING DECK)	MSAS 115 (1ST AVE N)	1989	4
82855	TH 494 EB	Mississippi R & UP RR	2003	3
95893A	5th St Gar(1st St	I 394	1986	3
20004	TH 57	S BR MID FK ZUMBRO RIVER	1996	3
27A32	4th AVE S	MIDTOWN GREENWAY	1997	3
27192	MINNEHAHA PARKWAY	MINNEHAHA CREEK	2000	2
54544	CR 129	MARSH RIVER	2000	2

References

ACI Committee 222, *Corrosion of Prestressing Steels*, American Concrete Institute, Farmington Hills, MI, February 2001 (accessed November 2011), http://www.bpesol.com/bachphuong/media/images/book/2222r_01.pdf.

ANSI/ASQC Z1.4, *Sampling Procedure and Tables for Inspection by Attributes*, American National Standard Institute, Washington, D.C., 1993.

Bricker, M.D. and Schokker, A.J., *Corrosion from Bleed Water in Grouted Post-Tensioned Tendons*, Portland Cement Association, Skokie, IL, 2004.

Corven Engineering, *Evaluation of the Plymouth Avenue Bridge*, City of Minneapolis Public Works Department, Minneapolis, MN, 2010.

Corven Engineering, *New Directions for Florida Post-Tensioned Bridges, Volume 1 – 11: Post-Tensioning in Florida Bridges*, Florida Department of Transportation, Tallahassee, FL, 2004 (accessed June 2011), <http://www.dot.state.fl.us/structures/posttensioning/NewDirectionsPostTensioningVol1.pdf>.

DMJM Harris, *Test and Assessment of NDT Methods for Post-Tensioning Systems in Segmental Balanced Cantilever Bridges*, Florida Department of Transportation, Central Structures Office Report, Tallahassee, FL, February 2003.

Dywidag Systems International, *Multistrand Post-Tensioning System*, 2011 (accessed August 2011), <http://www.dsiamerica.com/products/post-tensioning/strand-post-tensioning-system/anchorages/anchorage-types.html>.

Federal Highway Administration, *Recording and coding guide for the Structure Inventory and Appraisal of the Nation's Bridges*, U.S. Department of Transportation, Washington, D.C., December 1995 (accessed November 2011), <http://www.fhwa.dot.gov/bridge/mtguide.pdf>.

Hartt, W.H., and Venugopalan, S., *Corrosion Evaluation of Post-Tensioned Tendons on the Mid Bay Bridge in Destin, Florida*, Florida Department of Transportation, Tallahassee, FL, May 2002.

Bing, *Bing Maps*, Microsoft, 2011 (accessed August 2011), <http://www.bing.com/maps/>.

Minnesota Department of Transportation, *Bridge Inspection Manual, Version 1.8*, Minnesota Department of Transportation, St. Paul, MN, October 2009 (accessed June 2011), http://www.dot.state.mn.us/bridge/manuals/inspection/BridgeInspectionManual_Version1.8.pdf.

Nilson, A.H., *Design of Prestressed Concrete Second Edition*, New York, NY: John Wiley & Sons, 1987.

Post-Tensioning Institute, *Specification for Grouting of Post-Tensioned Structures 2nd Edition*, Post Tensioning Institute, Phoenix, AZ, 2003.

Sason, A.S., "Evaluation of Degree of Rusting on Prestressed Concrete Strand" *Journal of the Precast/Prestressed Concrete Institute*, Vol. 37, No. 3, 25-30, 1992.

Schokker, A.J., Hamilton, H.R., and Schupack, M., "Estimating Post-Tensioning Grout Bleed Resistance Using a Pressure-Filter Test," *Journal of the Precast/Prestressed Concrete Institute*, Vol. 47, No. 2, 32-39, 2002.

Schokker, A.J., and Schupack, M., "Thixotropic Grouts for Durable Post-Tensioned Construction," *Journal of the Precast/Prestressed Concrete Institute*, Vol. 1, No. 1, (January 2003), 22-27.

**Appendix A. Minnesota Post-Tensioned Bridges Built Prior to 2003:
Summaries and Inspection Recommendations**

Mn/DOT Contract 89261 WO 192:
Inspection of In-Place Bridges Constructed with Grouted Post-
Tensioned Tendons

Minnesota Post-Tensioned Bridges Built Prior to 2003

Summaries and Inspection Recommendations

Introduction

This document provides an overview of post-tensioned bridges in the Minnesota Department of Transportation inventory that were under construction prior to 2003 as part of Contract 89261, WO 192, *Inspection of In-Place Bridges Constructed with Grouted Post-Tensioned Tendons*. The intent of this document is to provide a basic reference and overview for selecting a small group of bridges for inspection. The bridges are organized by bridge type and then by year built (oldest to youngest). Ratings are given on a scale of 1-10 with 10 being the highest recommendation for inspection under this contract. Ratings are based on inspection notes, tendon configuration including tendon size and vertical rise, and any unusual factors that make the bridge of interest with respect to post-tensioning specifics. A summary is provided at the end of the document that includes the list of bridges recommended for inspection.

BOX-GIRDER BRIDGES

Bridge 27581

District: Metro Year built: 1974 Facility: Freeway Blvd Length: 86 ft Last inspection: 10/15/2009 NBI: Deck : 7	City: Brooklyn Center Bridge Type: PT box girder Feature: Shingle Creek Deck width: 58.7 ft Spans: 1 Super: 7	Sub: 8
--	--	---------------

Representative Figures



Example Cross Sections

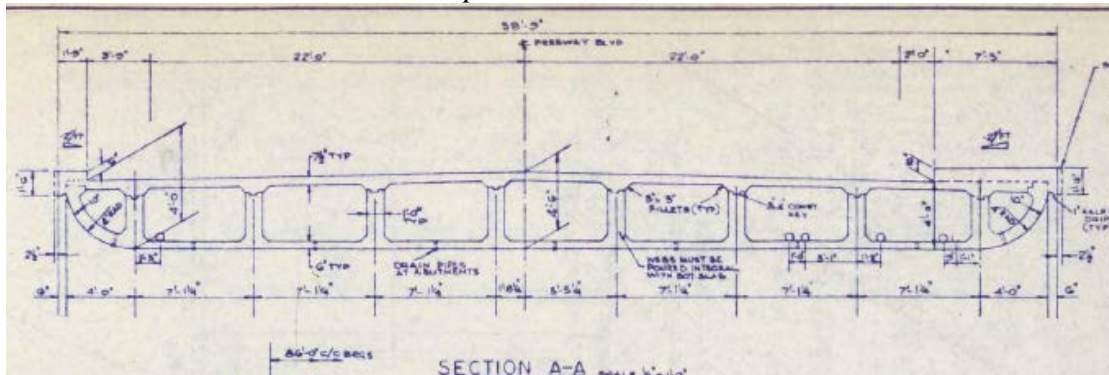

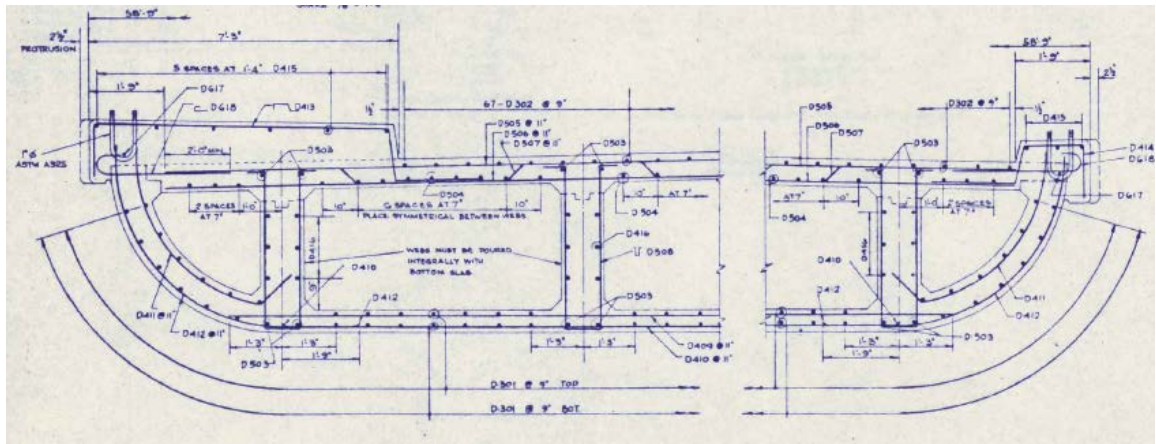

Example Tendon Profile

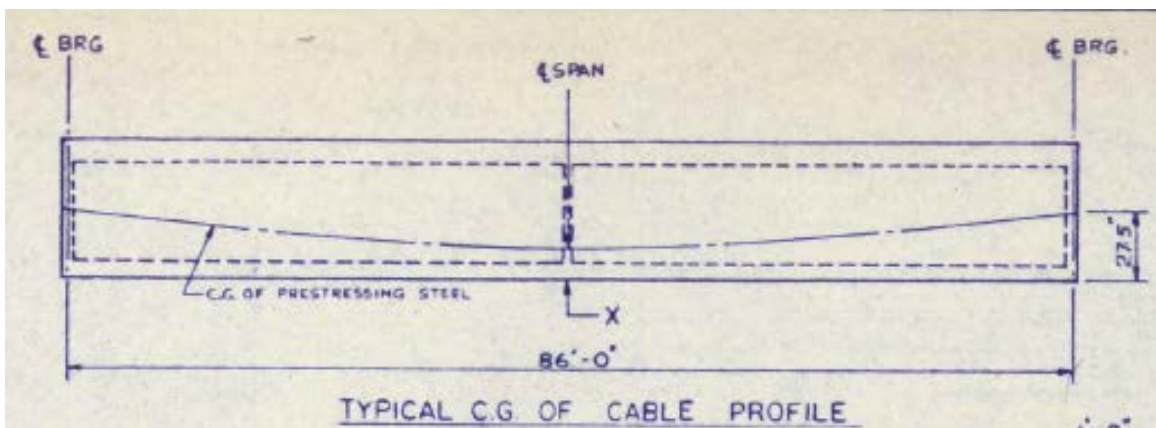

Inspection notes

(focused on PT indicators):

- Minor deck transverse and longitudinal cracking
- Box girder longitudinal cracking (about 20 feet) at each abutment
- Efflorescence from box girder cracks
- No access to interior of box girders

Discussion

From the provided plans, this structure is a cast-in-place box girder with no joints in the longitudinal direction between girders and no transverse post-tensioning. The most common area of concern for adjacent pretensioned box girders is ingress of chlorides and moisture through reflective longitudinal deck cracking above the joint between girders. In this cast-in-place post-tensioned case, this concern is much less likely and only minor cracking is reported in the inspection notes.

The longitudinal rise of the post-tensioning tendons is less than 3 feet and thus should not be a major concern for bleed problems near the anchorages. The longitudinal cracking is of interest to determine whether this is an indication of cracking along the tendon line (that may indicate potential tendon corrosion).

Detailed inspection recommendation = 5

(1 lowest to 10 highest)

Bridge 27593

District:	Metro	City:	Minneapolis
Year built:	1974	Bridge Type:	PT box girder
Facility:	34 th Ave S	Feature:	Minnehaha Creek
Length:	126 ft	Deck width:	70 ft
Last inspection:	6/24/2009	Spans:	1
NBI:	Deck : 7	Super: 7	Sub: 8

Representative Figures



Example Cross Sections

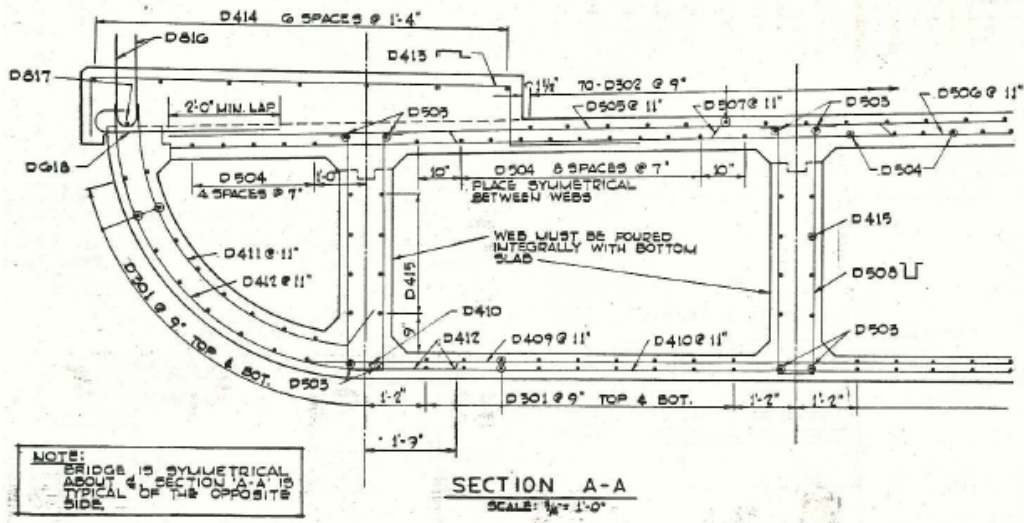
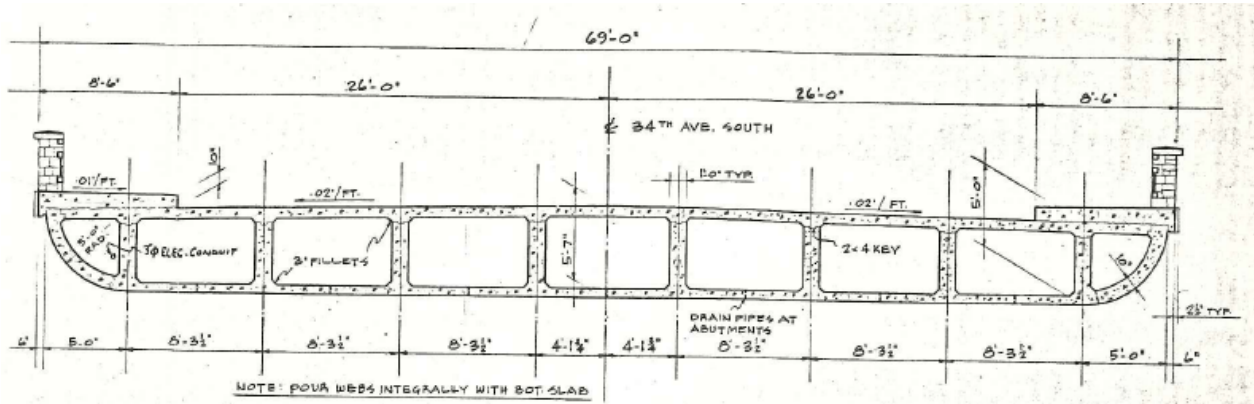

Example Tendon Profile

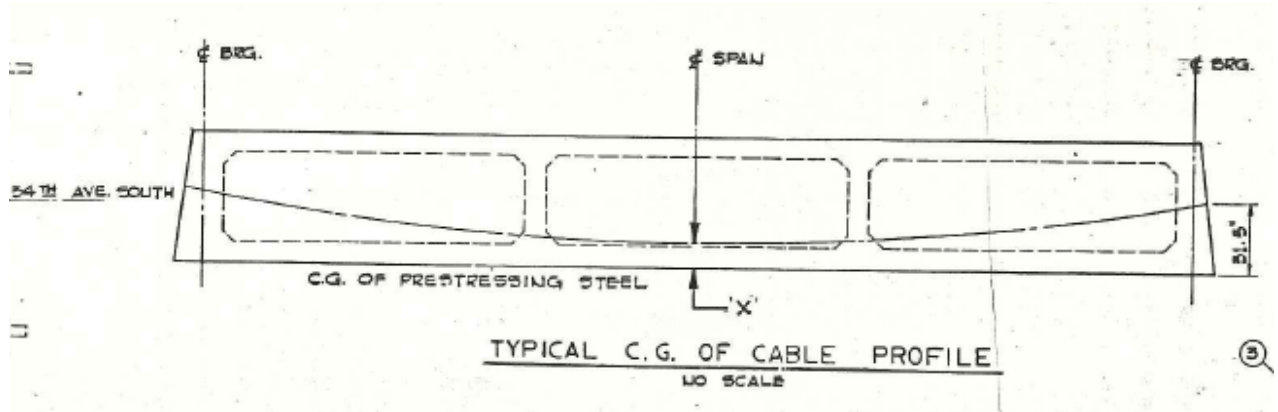

Inspection notes

(focused on PT indicators):

- Deck: map cracking, some transverse cracking, some spalled areas
- Box girder diagonal cracks at corners with staining and efflorescence
- Some rust staining at weep holes

- Some fine longitudinal cracking
- Underside fine longitudinal cracking with staining, efflorescence, and leaching
- No access to interior of box girders

Discussion

From the provided plans, this structure is a cast-in-place box girder with no joints in the longitudinal direction between girders and no transverse post-tensioning. The most common area of concern for adjacent pretensioned box girders is ingress of chlorides and moisture through reflective longitudinal deck cracking above the joint between girders. In this cast-in-place post-tensioned case, this concern is much less likely and only minor cracking is reported in the inspection notes.

The longitudinal rise of the post-tensioning tendons is less than 3 feet and thus not a major concern for bleed problems near the anchorages. The longitudinal cracking on the sides and bottoms of the box girders is of interest to determine whether this is an indication of cracking along the tendon line (that may indicate potential tendon corrosion). Additionally, staining and efflorescence at weep holes may be an indicator of problems within the box. The diagonal cracking with staining and efflorescence at the corners of the box is also of interest depending on the size/length/location of the cracking.

Detailed inspection recommendation = 7
(1 lowest to 10 highest)

Bridge 27611

District:	Metro	City:	Minneapolis
Year built:	1980	Bridge Type:	PT box girder
Facility:	Plymouth Ave	Feature:	Mississippi River
Length:	944 ft	Deck width:	77 ft
Last inspection:	9/2/2009	Spans:	5
NBI:	Deck : 7	Super:	7
		Sub:	8

Representative Figures



Example Cross Sections

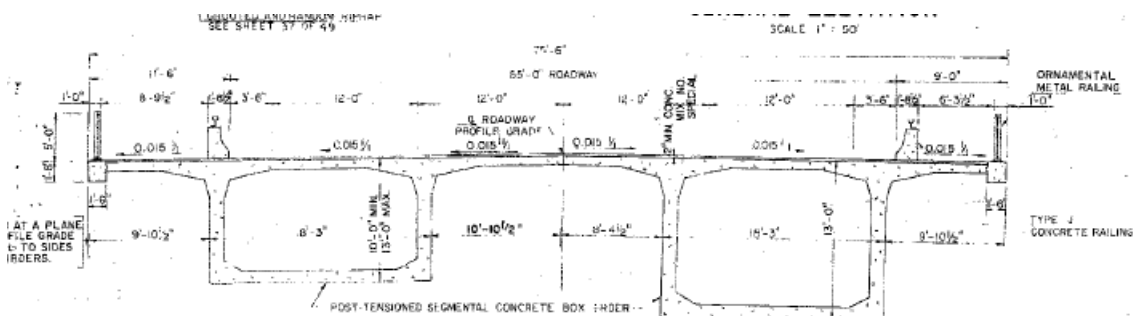

Example Tendon Profile

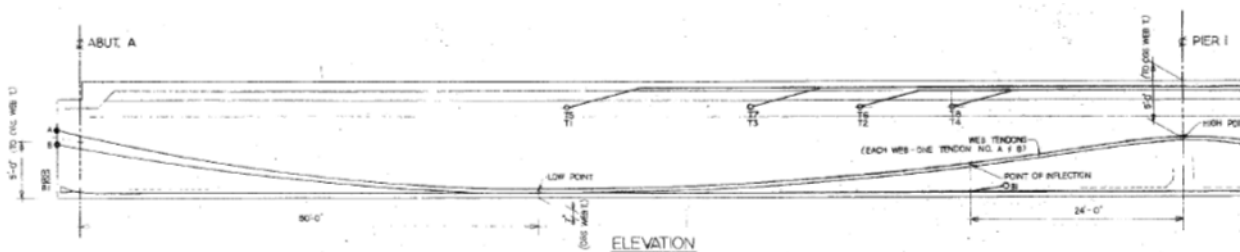

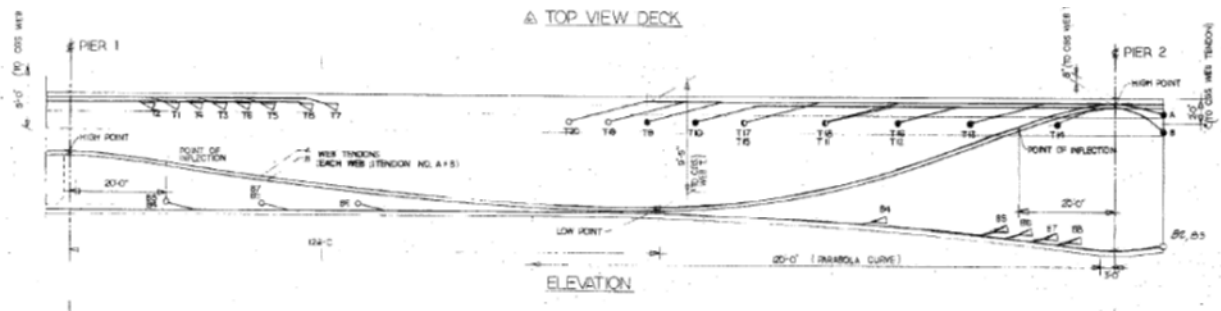

Inspection and Discussion

(focused on PT indicators):

This bridge was closed in the fall of 2010 due to evidence of major corrosion in the box girder. The City of Minneapolis hired a consultant (Corven Engineering) to evaluate the bridge and to recommend repair options. Additionally, this bridge was then included for inspection under the Mn/DOT contract that is sponsoring this report. Andrea Schokker and the inspection team from VStructural, LLC did an inspection on site in December of 2011. These detailed findings will be included in the final report with the other bridges that will be inspected under this contract.

Detailed inspection recommendation= 10

(1 lowest to 10 highest)

The level of 10 for inspection recommendation is based on the visual inspection of the interior of the bridge.

Bridge 27622

District:	Metro	City:	Brooklyn Center
Year built:	1980	Bridge Type:	PT box girder
Facility:	SB Shin Creek P (109)	Feature:	Shingle Creek
Length:	104 ft	Deck width:	38.2 ft
Last inspection:	8/1/2008	Spans:	1
NBI:	Deck : 7	Super: 8	Sub: 8

Representative Figures



Example Cross Sections

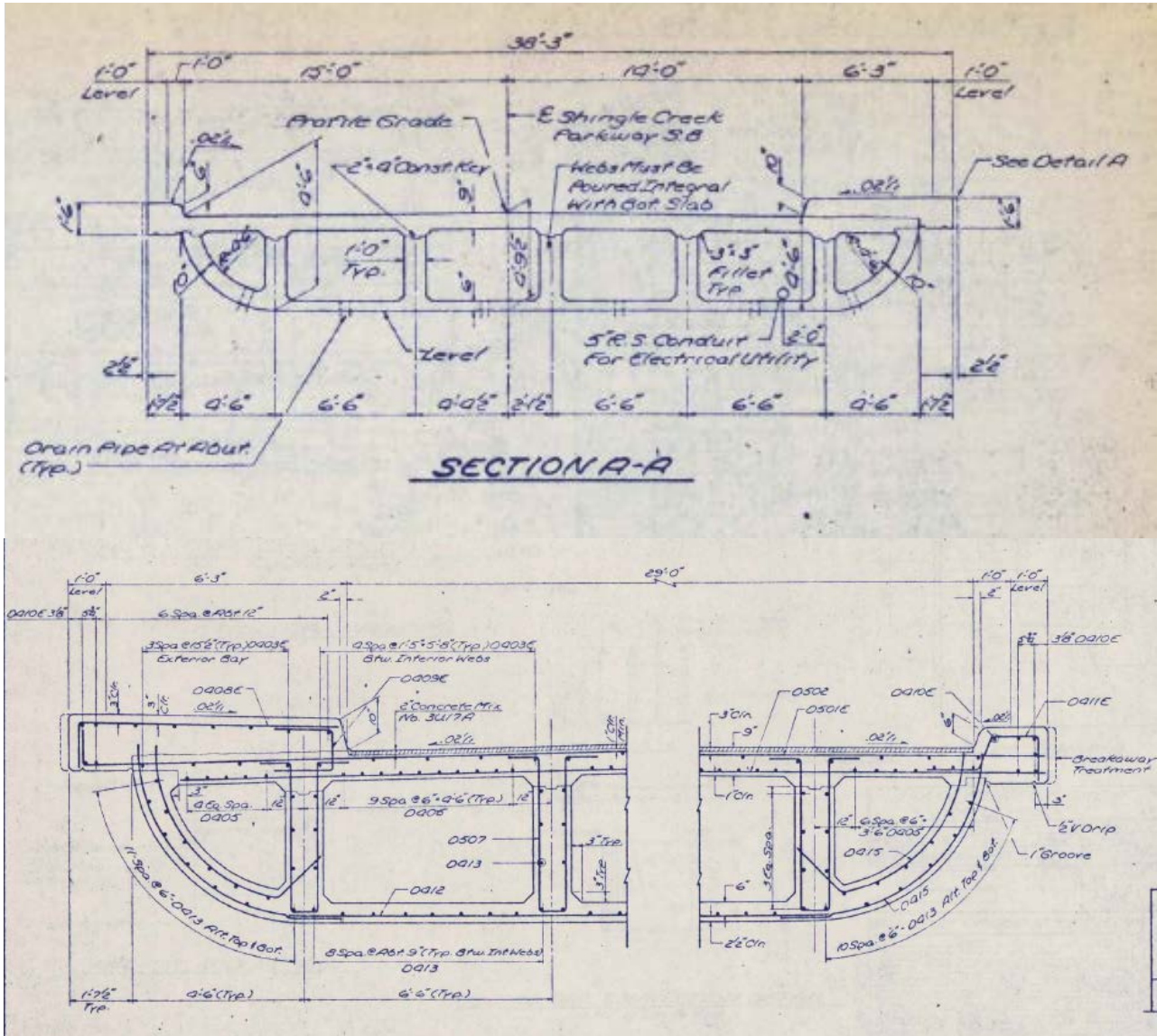

Example Tendon Profile

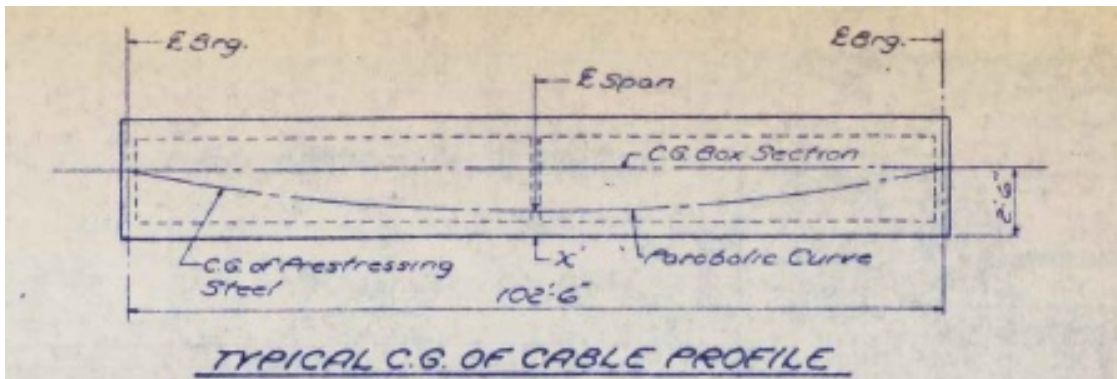

Inspection notes
(focused on PT indicators):

- Transverse and longitudinal cracking throughout deck (moderate crack size)
- Box girder minor longitudinal cracking along east abutment with some rust staining
- Unable to observe deck underside

Discussion

From the provided plans, this structure is a cast-in-place box girder with no joints in the longitudinal direction between girders and no transverse post-tensioning. The most common area of concern for adjacent pretensioned box girders is ingress of chlorides and moisture through reflective longitudinal deck cracking above the joint between girders. In this cast-in-place post-tensioned case, this concern is much less likely although there is cracking throughout the deck (moderate crack size) reported in the inspection notes.

The longitudinal rise of the post-tensioning tendons is less than 3 feet and thus not a major concern for bleed problems near the anchorages. The longitudinal cracking is of interest to determine whether this is an indication of cracking along the tendon line (that may indicate potential tendon corrosion). The underside of the bridge was not able to be inspected. For a structure of this type, the underside can be a good indicator of problems in the interior of the box girders, so this should be considered in the next inspection.

Detailed inspection recommendation = 4
(1 lowest to 10 highest)

Bridge 27264 (LRT)

District:	Metro	City:	Minneapolis
Year built:	2002	Bridge Type:	PT box girder
Facility:	LRT	Feature:	TH 55, 62 and Ramp
Length:	1342 ft	Deck width:	28.0 ft
Last inspection:	4/30/2008	Spans:	8
NBI:	Deck : 8	Super: 8	Sub: 8

Representative Figures



Example Cross Sections

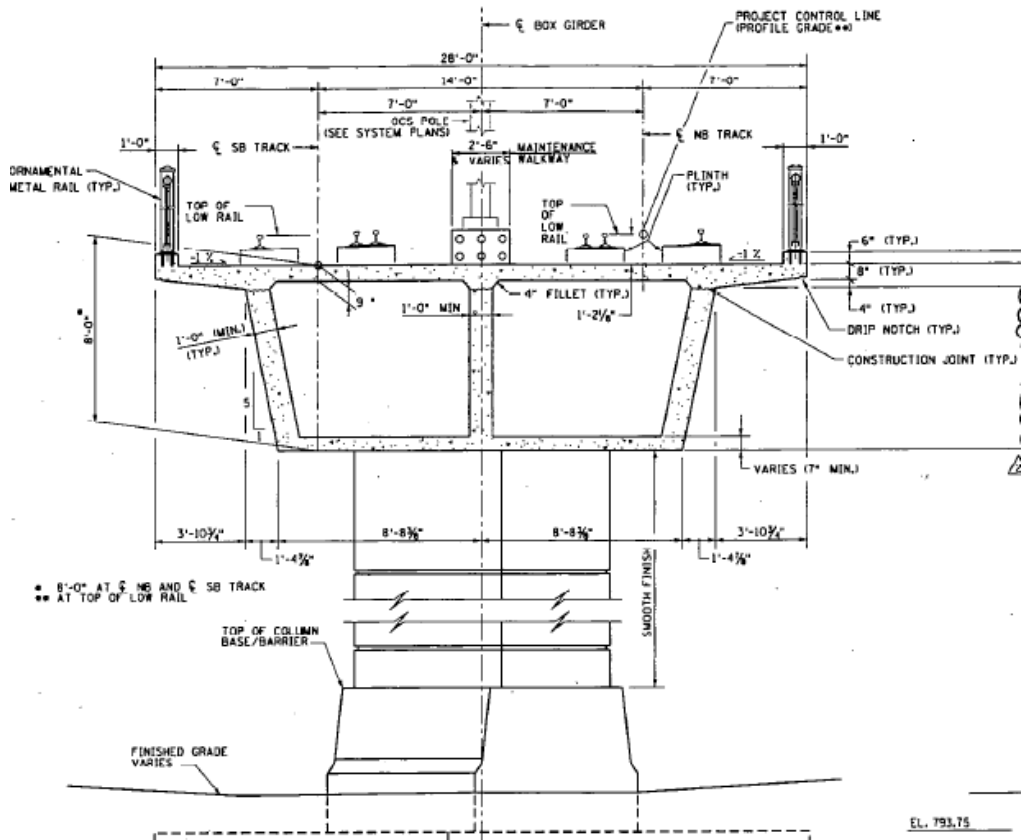

Example Tendon Profile

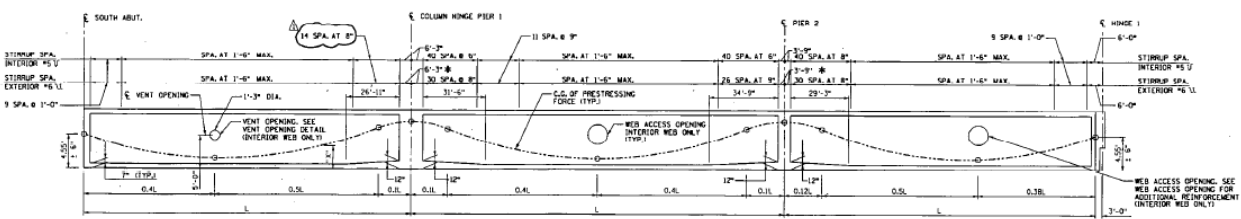

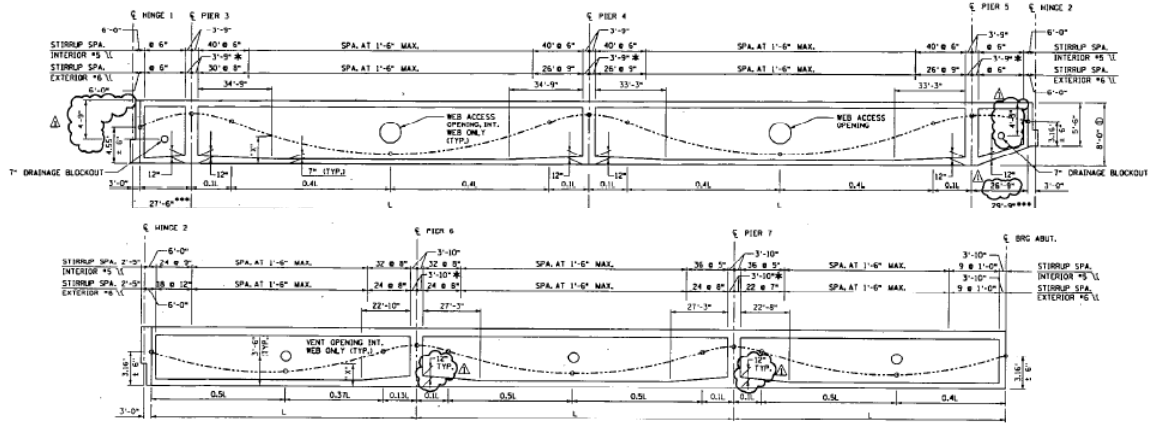

Inspection notes

(focused on PT indicators):

- Small spall on W fascia above on-ramp to WB TH-55
- 6 sq in of delamination with some exposed rebar on the W cell side of the center web near the web access opening in span #4
- Cracking at set of cantilever portion of hinge 2; efflorescence and additional longitudinal crack on the bottom of the bottom slab

Discussion

This light rail bridge has a few areas of specific interest as outlined in the inspection notes. These should be visually inspected with respect to potential problems related to PT anchorages and PT tendon profile. The parabolic drapes is moderate, so moderate bleed voids may be present at high points.

Detailed inspection recommendation = 7

(1 lowest to 10 highest)

Bridge 27717

District:	Metro	City:	Minneapolis
Year built:	1980	Bridge Type:	PT box girder
Facility:	I 94	Feature:	Shingle Creek
Length:	77 ft	Deck width:	156.3 ft
Last inspection:	9/29/2009	Spans:	1
NBI:	Deck : 7	Super:	7
		Sub:	7

Representative Figures



Example Cross Sections

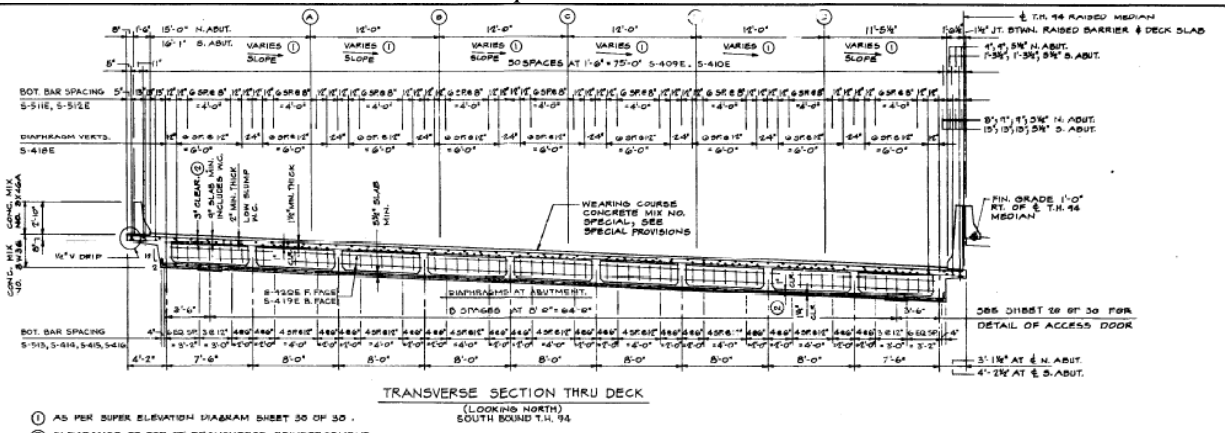

Example Tendon Profile

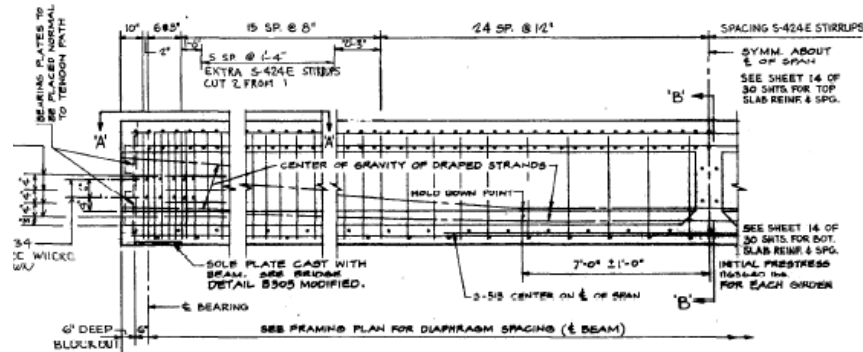

Inspection notes

(focused on PT indicators):

- Some deck spalling
- No inspection info on PT boxes

Discussion

The available inspection notes (2009) describe the PT girder info from plans rather than observations from site. Two access hatches per box are mentioned. No other information is available. Based on the inspection reports, no major concerns are noted, however the listing of NBI ratings at 7 for the deck, superstructure, and substructure are questionable without having supporting information in the inspection report.

From the provided plans, this structure is a cast-in-place box girder with no joints in the longitudinal direction between girders and no transverse post-tensioning. The most common area of concern for adjacent pretensioned box girders is ingress of chlorides and moisture through reflective longitudinal deck cracking above the joint between girders. In this cast-in-place post-tensioned case, this concern is much less likely, particularly if no problems are indicated during inspection. The vertical tendon rise is not high enough to expect significant concern with bleed.

Detailed inspection recommendation = 4

(1 lowest to 10 highest)

Bridge 27904

District:	Metro	City:	Brooklyn Center
Year built:	1980	Bridge Type:	PT box girder
Facility:	I 94 WB on ramp	Feature:	Shingle Creek
Length:	98 ft	Deck width:	27.6 ft
Last inspection:	5/21/2009	Spans:	1
NBI:	Deck : 7	Super:	7
		Sub:	7

Representative Figures



Example Cross Sections

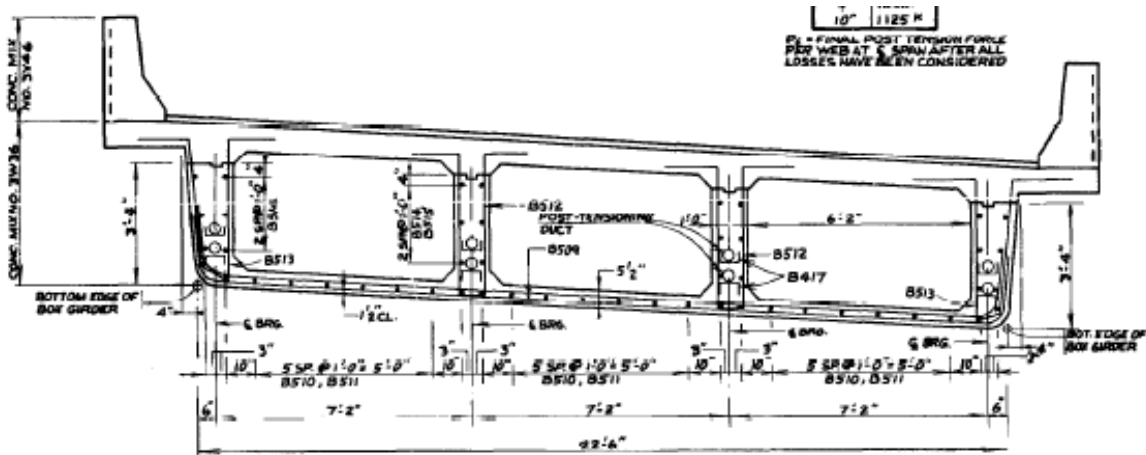

Example Tendon Profile

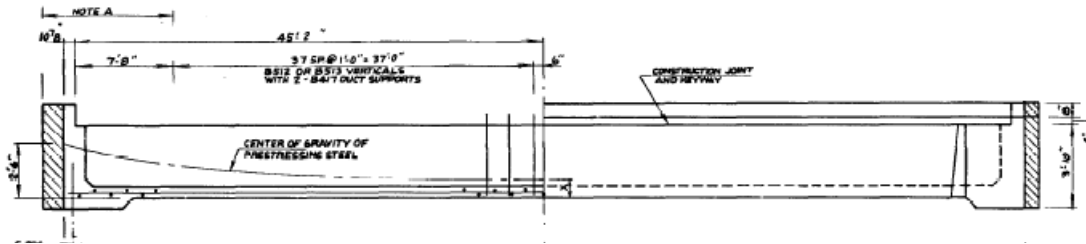

Inspection notes

(focused on PT indicators):

- No information on deck or PT

Discussion

The inspection from 2009 has no inspection information (other than from plans) on the deck or PT girders. No other information is available. Based on the inspection reports, no major concerns are noted, however the listing of NBI ratings at 7 for the deck, superstructure, and substructure are questionable without having supporting information in the inspection report. From the provided plans, this structure is a cast-in-place box girder with no joints in the longitudinal direction between girders and no transverse post-tensioning. The most common area of concern for adjacent pretensioned box girders is ingress of chlorides and moisture through reflective longitudinal deck cracking above the joint between girders. In this cast-in-place post-tensioned case, this concern is much less likely, particularly if no problems are indicated during inspection. The vertical tendon rise is not high enough to expect significant concern with bleed.

Detailed inspection recommendation = 4

(1 lowest to 10 highest)

Bridge 27719

District:	Metro	City:	Minneapolis
Year built:	1982	Bridge Type:	PT box girder
Facility:	Lyndale Ave N	Feature:	Shingle Creek
Length:	93 ft	Deck width:	70.3 ft
Last inspection:	8/17/2009	Spans:	1
NBI:	Deck : 7	Super: 8	Sub: 8

Representative Figures



Example Cross Sections

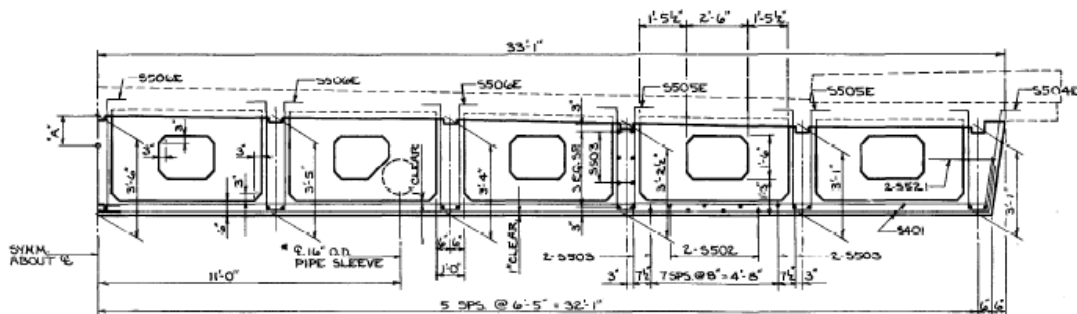

Example Tendon Profile

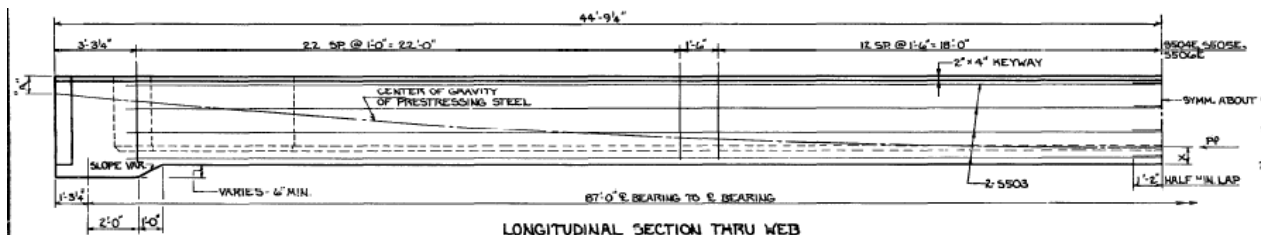

Inspection notes

(focused on PT indicators):

- Deck: sealed and unsealed longitudinal cracks as well as map cracking
- Snooper used to evaluate PT boxes (appears to include access into boxes)
 - Spalling and patching noted on diaphragms
 - Honey combing in one of the boxes (5th from west)
- Galvanized sheathing for bottom of deck inside boxes
- Some fine transverse cracks on underside of boxes

Discussion

Spalling and/or patching is mentioned for nearly all diaphragms inspected. A visual inspection inside the box should be done with particular focus on whether the cracking or spalling is related to the post-tensioning or in an area that would make the post-tensioning tendons more susceptible to corrosion.

Detailed inspection recommendation = 8

(1 lowest to 10 highest)

Bridge 27810

District:	Metro	City:	Minneapolis
Year built:	1982	Bridge Type:	PT box girder
Facility:	I 94	Feature:	Pedestrian Path
Length:	74 ft	Deck width:	152.3 ft
Last inspection:	9/29/2009	Spans:	1
NBI:	Deck : 7	Super:	7
		Sub:	7

Representative Figures



Example Cross Sections

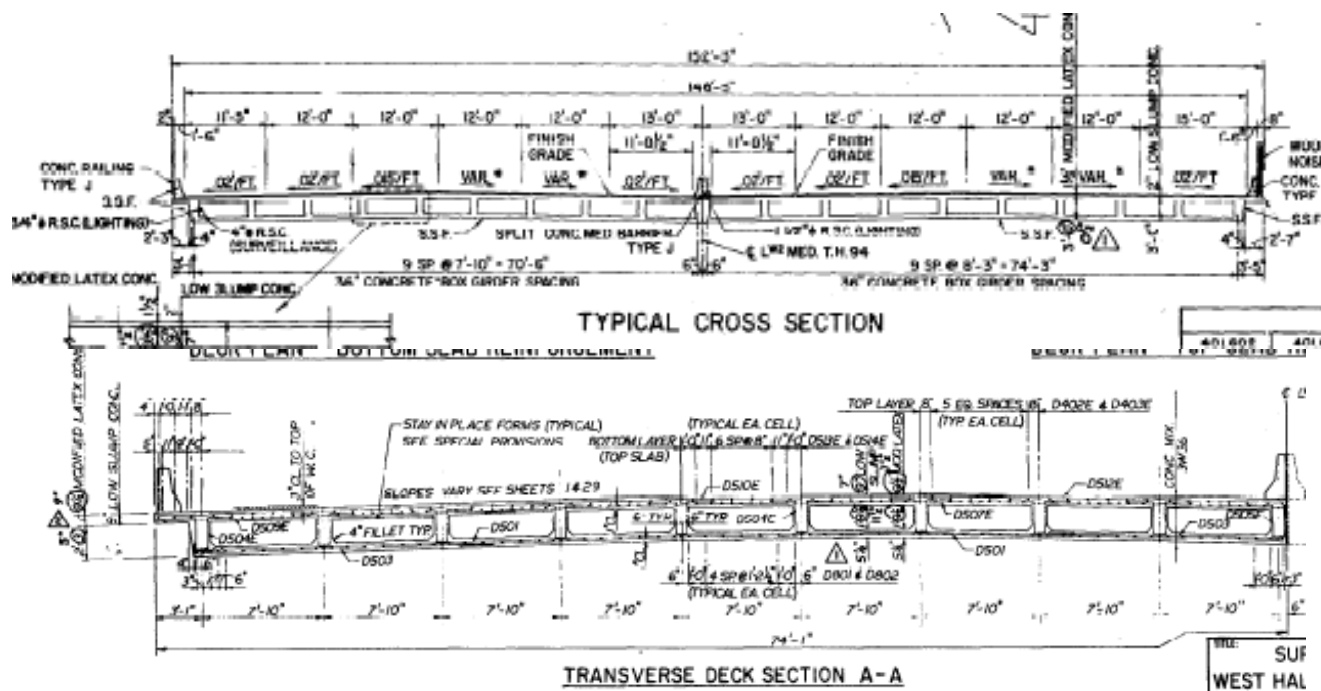

Example Tendon Profile

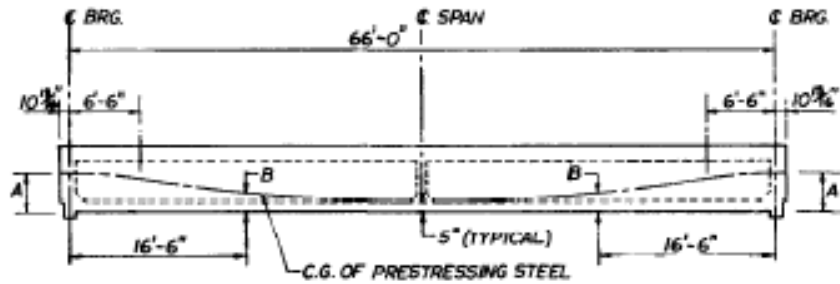

TYPICAL C. G. OF TENDON PROFILE

NO SCALE

Inspection notes

(focused on PT indicators):

- No problems indicated on inspection from 2009

Discussion

The inspection from 2009 has no inspection information (other than from plans) on the PT girders. No other information is available. Based on the inspection reports, no major concerns are noted, however the listing of NBI ratings at 7 for the deck, superstructure, and substructure are questionable without having supporting information in the inspection report.

From the provided plans, this structure is a cast-in-place box girder with no joints in the longitudinal direction between girders and no transverse post-tensioning. The most common area of concern for adjacent pretensioned box girders is ingress of chlorides and moisture through reflective longitudinal deck cracking above the joint between girders. In this cast-in-place post-tensioned case, this concern is much less likely, particularly if no problems are indicated during inspection. The vertical tendon rise is not high enough to expect significant concern with bleed.

Detailed inspection recommendation = 4

(1 lowest to 10 highest)

Bridge 69818 N

District:	1	City:	Duluth
Year built:	1985	Bridge Type:	PT box girder
Facility:	0.3 Mi SW of JCT 5 th Ave	Feature:	I-35 (NB & SB)
Length:	2736 ft	Deck width:	42.4 ft
Last inspection:	10/09/2008	Spans:	30 (see drawings)
NBI:	Deck : 7	Super: 7	Sub: 8

Representative Figures



Example Cross Sections

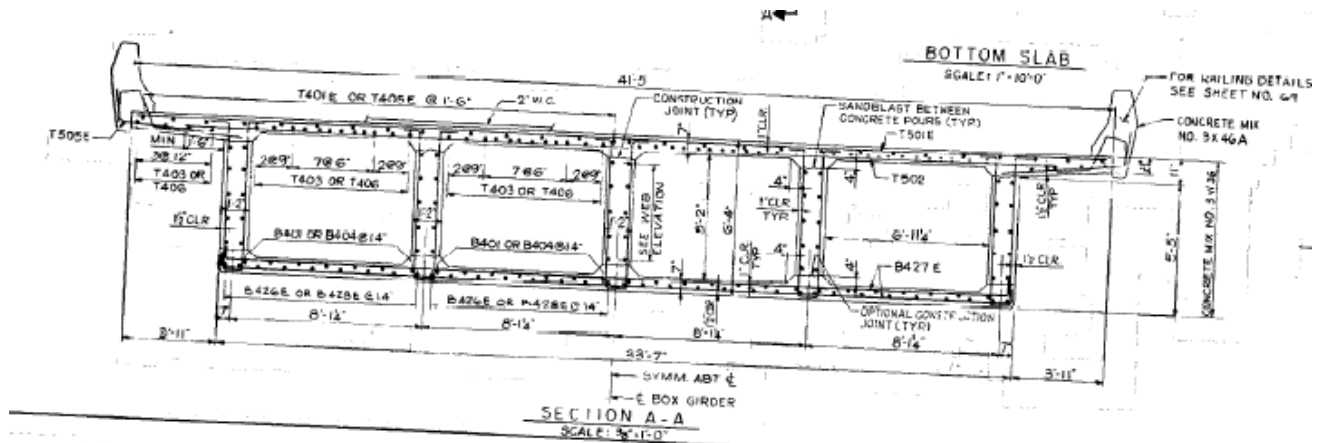

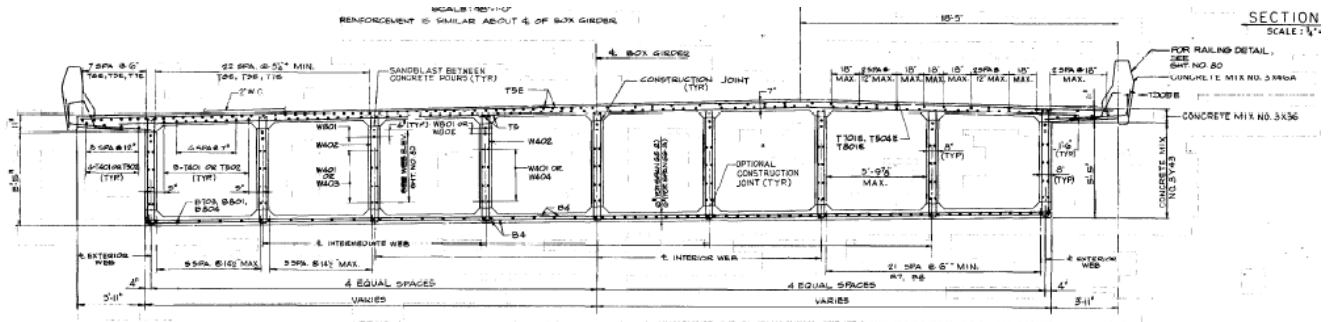

SECTION B-B
SCALE: 1/8"=1'-0"
REINFORCEMENT IS SIMILAR ABOUT 1/4 OF BOX GIRDER

Example Tendon Profiles

NOTE: CONCRETE COVERS ARE SPECIFIED IN SECTION A-A ABOVE.

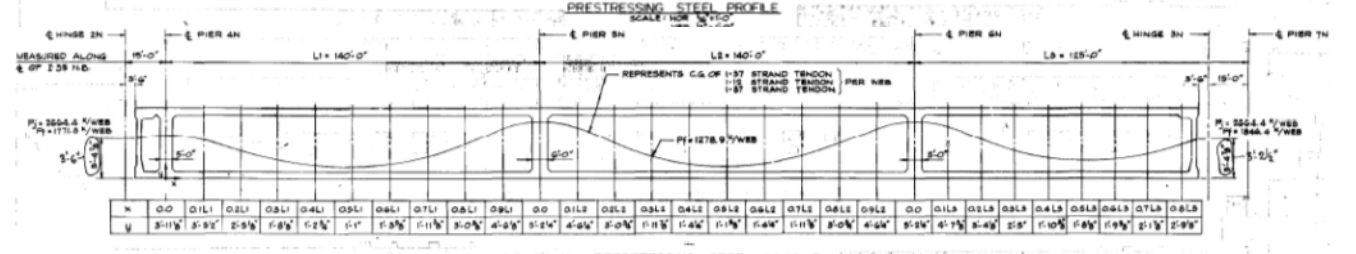
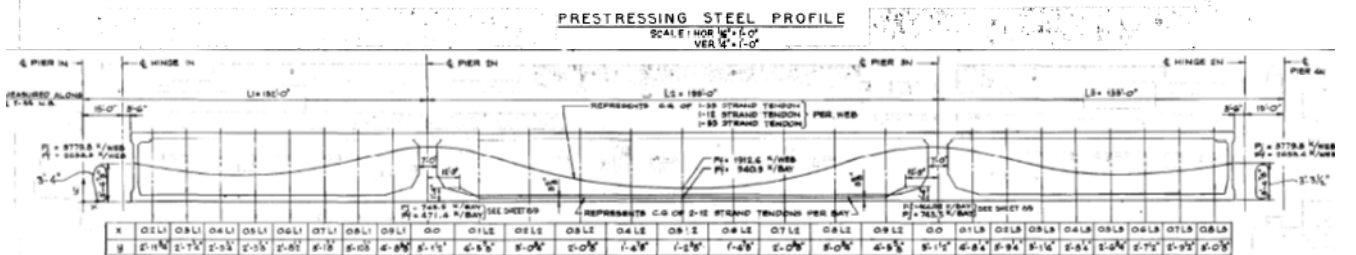
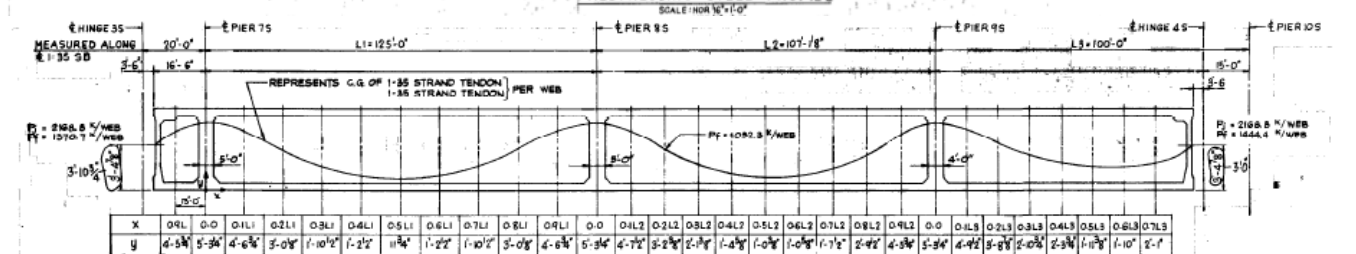
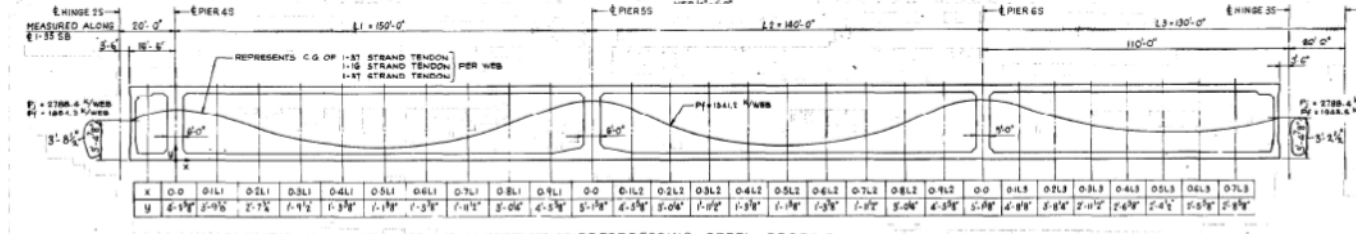
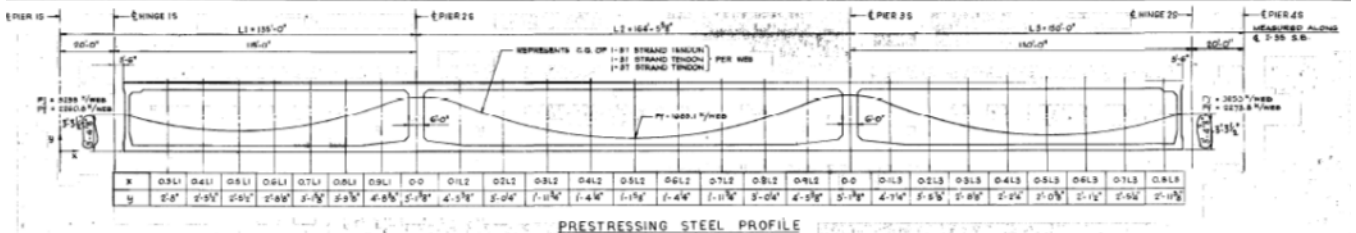

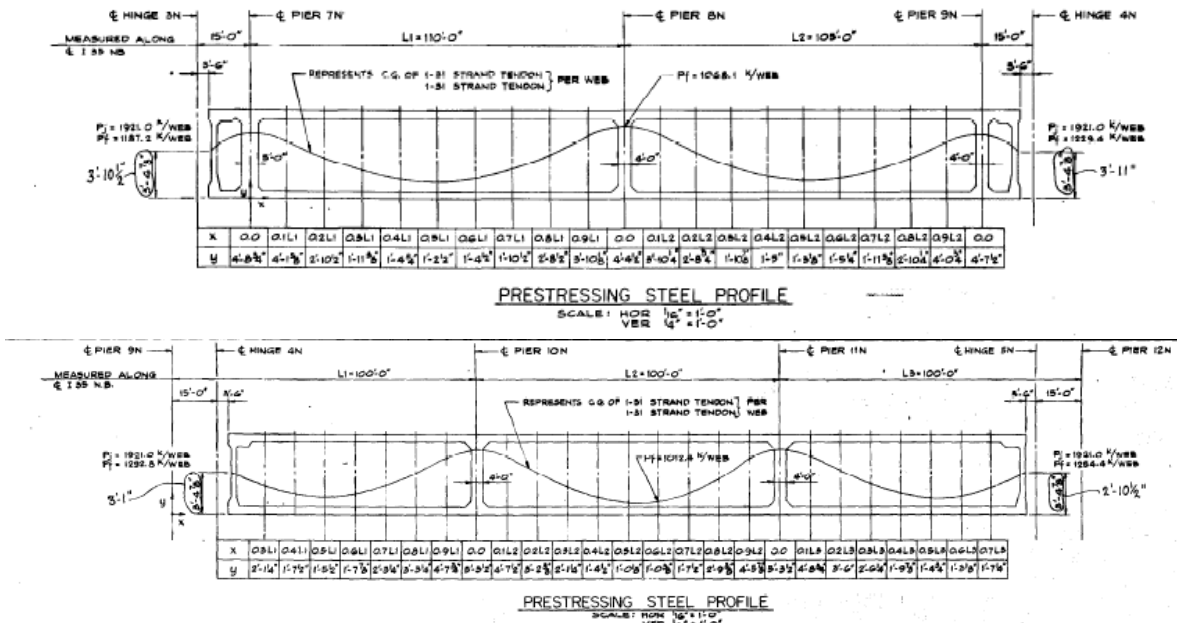

Inspection notes

(focused on PT indicators):

- Inspection by snooper
- Consultants unable to access interior of boxes
- Deck spalling and heavy cracking
- Large spalls in poured deck joint
- Plugged and clogged drains
- Web cracking (vertical and shear) including at end diaphragms
- Delaminated areas in box section

Discussion

This multi-cell box girder bridge has relatively large internal tendons (up to 37 strands per duct) in a parabolic profile. The grout used in the mid-80's for this structure was highly unlikely to be bleed resistant and may have included expansive admixture. The combination of the large number of tendons to be grouted, tendon size, tendon profile, and potential drainage issues make this structure a good candidate for invasive inspection at likely void locations. Selected anchor regions should be checked via boroscope to determine the extent of voids (if any) along with the condition of the strand. Intermediate high points coincide with diaphragm areas, so selected locations just outside the diaphragm should be targeted to investigate voids away from the anchor region.

An internal visual inspection of the box should be completed to look for signs of problems in the web tendons. The inspection reports describe web cracking that may indicate loss of tendon capacity or the cracking may have been in place since original stressing. Spalling in the deck and particularly at the poured joint may point to areas of potential ingress for moisture and chlorides into the box. The condition of the interior of the box with respect to visual indicators of moisture ingress is important to isolate potential problem areas.

Inspection as described above is recommended for this bridge.

Detailed inspection recommendation = 8
(1 lowest to 10 highest)

Bridge 69818 S

District:	1	City:	Duluth
Year built:	1985	Bridge Type:	PT box girder
Facility:	I 35 SB	Feature:	SL&LC RR & TH 194 NB
Length:	2,732 ft	Deck width:	42.4 ft
Last inspection:	8/18/2008	Spans:	~30 (Reference Plans)
NBI:	Deck : 7	Super: 7	Sub: 8

Representative Figures



Example Cross Sections

See Plans for bridge 69818 N

Example Tendon Profile

See Plans for bridge 69818 N

Inspection notes

(focused on PT indicators):

- Light vertical cracks with efflorescence at regular intervals along girders
- Shear cracks in all girder walls and some leaching in cracks at end of girders
- Notes indicate inspection inside in 2007 (not available)

Discussion

This is the sister structure to 69818N. The inspection reports for the two structures differ (and had different inspectors), but both indicate a significant amount of cracking. This structure should be inspected further along with 69818N as part of this project.

Detailed inspection recommendation = 8
(1 lowest to 10 highest)

Bridge 02034

District: Metro
Year built: 1996
Facility: US 10 EB on Ramp
Length: 407 ft
Last inspection: 9/17/2009
NBI: Deck : 7

City: Coon Rapids
Bridge Type: PT box girder
Feature: MN 47 SB
Deck width: 55.77 ft
Spans: 3
Super: 8
Sub: 7

Representative Figures



Example Cross Sections

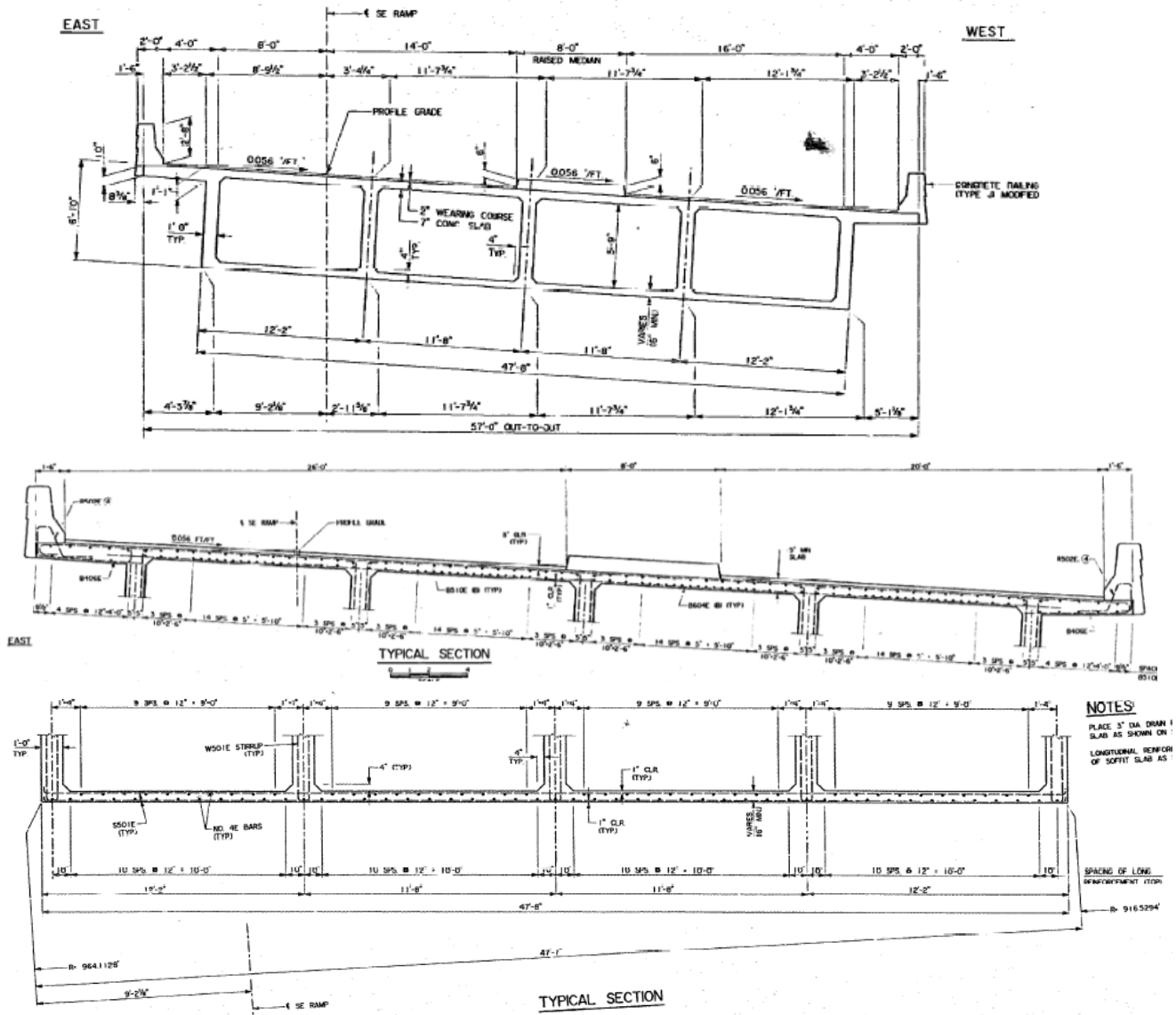

Example Tendon Profile

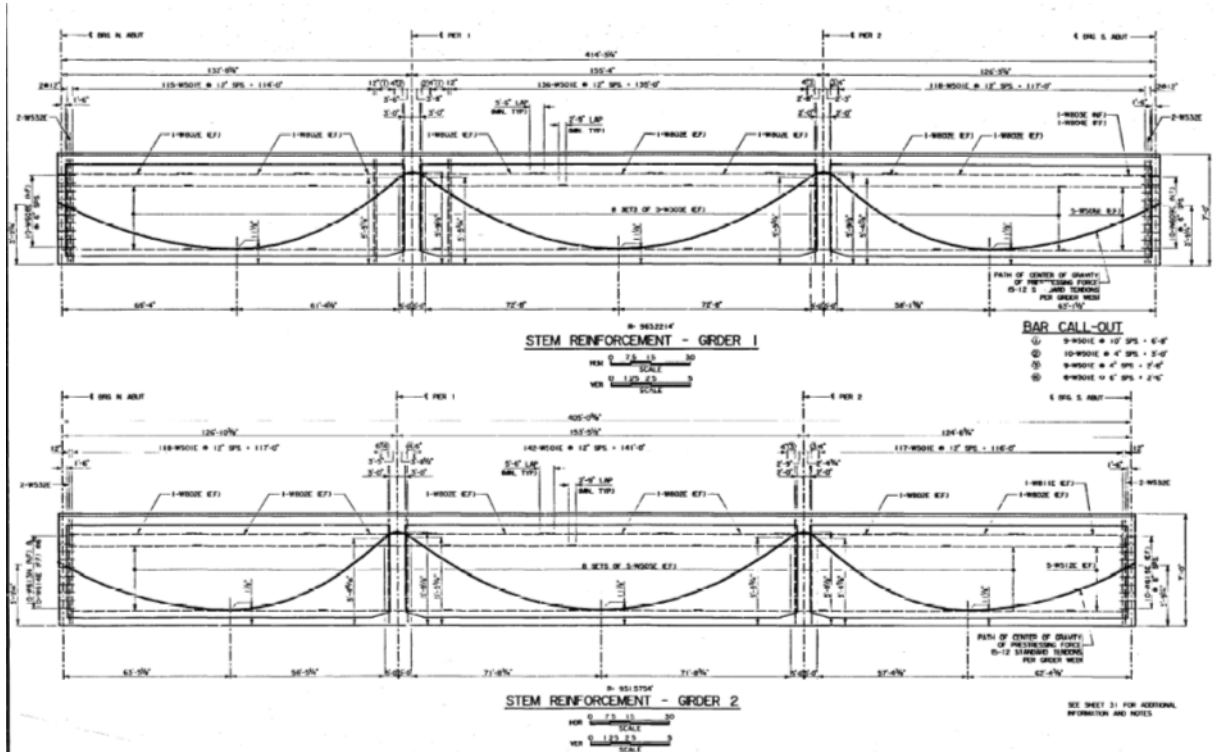

Inspection notes

(focused on PT indicators):

- PT pier cap #1 has vertical cracks with leaching
- Deck cracking up to 1/4" width
- Cracking inside boxes

Discussion

Deck cracking of 1/4" is significant. Cracking requiring epoxy fill inside the box is also of interest as a sign of PT related problems or potential for corrosion. A full visual inspection of the box interiors is recommended for this bridge. The 2009 inspection report does not have any information specific to the PT boxes. The parabolic drape profile does not have a tall vertical rise, but this layout may be susceptible to bleed problems near intermediate high points and end anchors.

Detailed inspection recommendation = 8

(1 lowest to 10 highest)

Bridge 62555A (Wabasha)

District:	Metro	City:	St. Paul
Year built:	1996	Bridge Type:	PT box girder
Facility:	.7 Mi SE of TH 35E + 94	Feature:	Miss River & RR &STR's
Length:	1,253 ft	Deck width:	47.7 ft
Last inspection:	9/15/2009	Spans:	-
NBI:	Deck : 8	Super: 8	Sub: 8

Representative Figures



Example Cross Sections

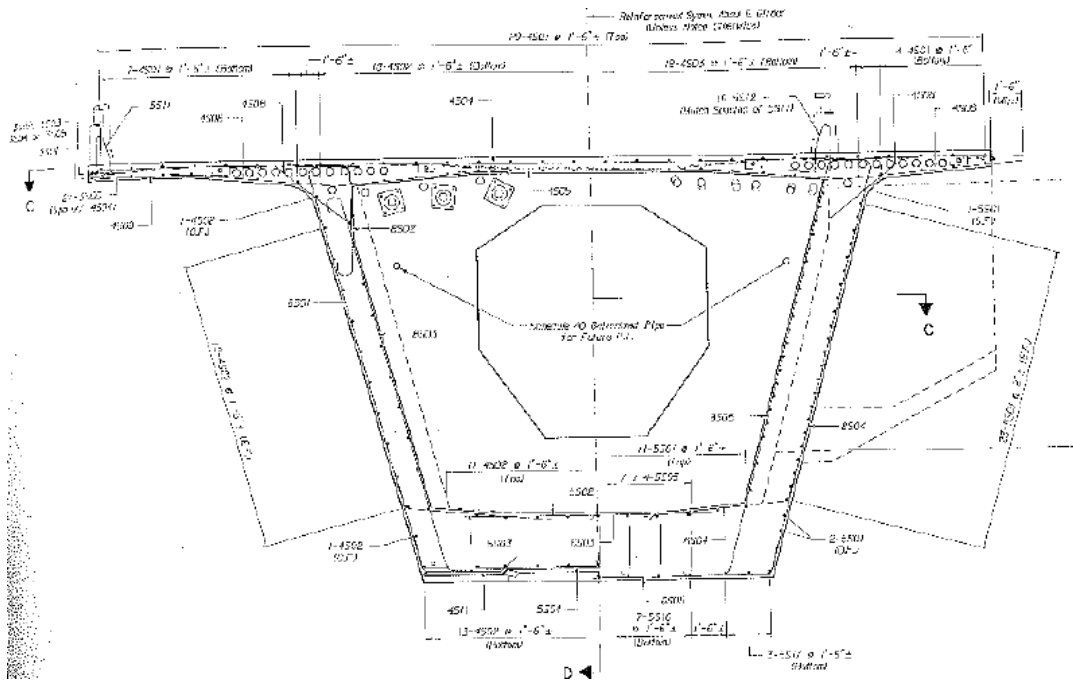

Example Tendon Profile

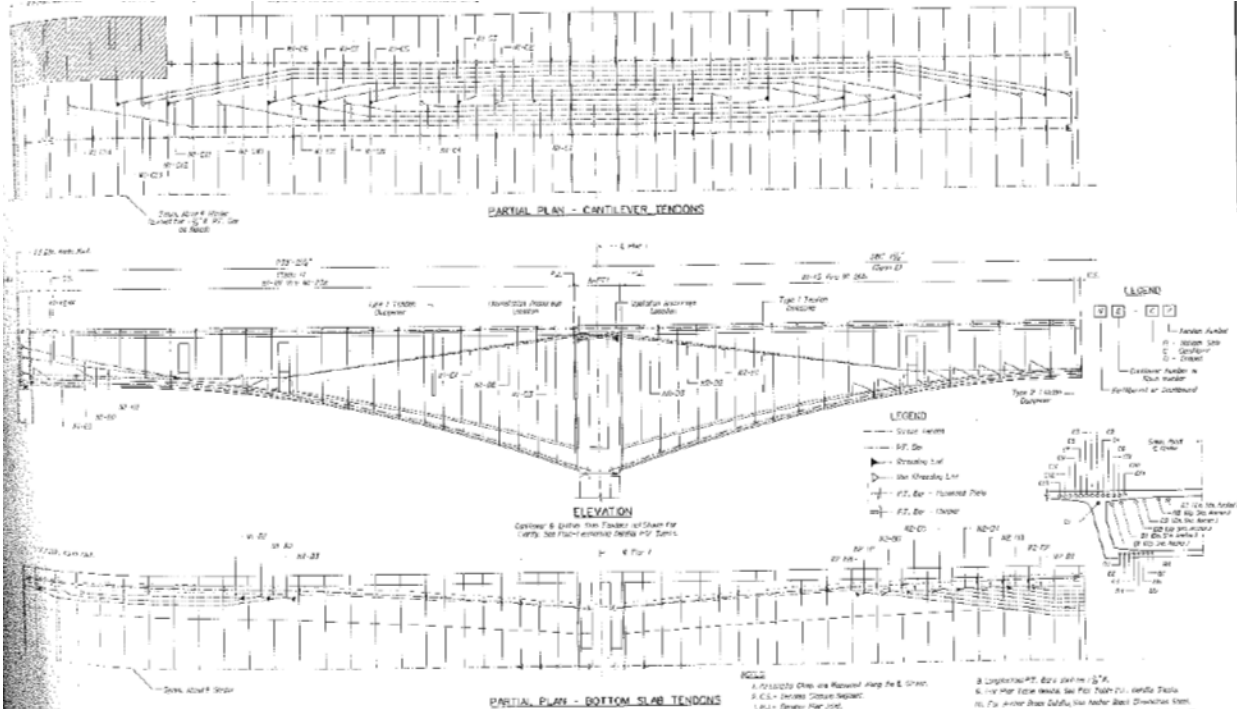

Inspection notes

(focused on PT indicators):

- Spalling at grout tube location on deck
- PT girders show some efflorescence in transverse joints along bottom; paint peeling in these locations
- Longitudinal cracks in top of box near south abutment cross walk
- Interior inspection of box girders in 2005 (team included Tom DeHaven of Figg)
- Anchor block joint is open 1/4"

Discussion

The spalled area at the grout port to the deck should be revisited. This type of detail can allow direct ingress of moisture and chlorides to a tendon. The anchor block joint should also be visually inspected for signs of corrosion from moisture/chloride ingress. No major problems were indicated in the 2005 inspection. This bridge has a specific inspection manual from the designers (Figg Bridge) and has been inspected with one of the Figg team who has extensive segmental bridge experience on site. For this reason, the inspection recommendation under this project is lower than for other bridges of this type.

Detailed inspection recommendation = 6

(1 lowest to 10 highest)

Bridge 62555B (Wabasha)

District:	Metro	City:	St. Paul
Year built:	1996	Bridge Type:	PT box girder
Facility:	.7 Mi SE of TH 35E + 94	Feature:	Miss River & RR &STR's
Length:	1,253 ft	Deck width:	47.7 ft
Last inspection:	11/10/2009	Spans:	-
NBI:	Deck : 8	Super: 8	Sub: 8

Representative Figures



Inspection notes

(focused on PT indicators):

- Transverse deck cracking at numerous locations on the inside southbound lane
- Slight efflorescence along bottom of PT girders at transverse joints
- Thermal cracks at 3 construction joints

Discussion

This structure is the sister bridge to 62555A and in general, has similar inspection notes with respect to transverse joints. Thermal cracking at the construction joints is also noted. These areas of cracking should be inspected visually from inside of the box.

Detailed inspection recommendation = 6

(1 lowest to 10 highest)

Bridge 02037 E

District:	Metro	City:	Coon Rapids
Year built:	1997	Bridge Type:	PT box girder
Facility:	US 10 EB	Feature:	University Ave & MN 610
Length:	479 ft	Deck width:	49.21 ft
Last inspection:	9/28/2009	Spans:	3
NBI:	Deck : 7	Super: 8	Sub: 7

Representative Figures



Example Cross Sections

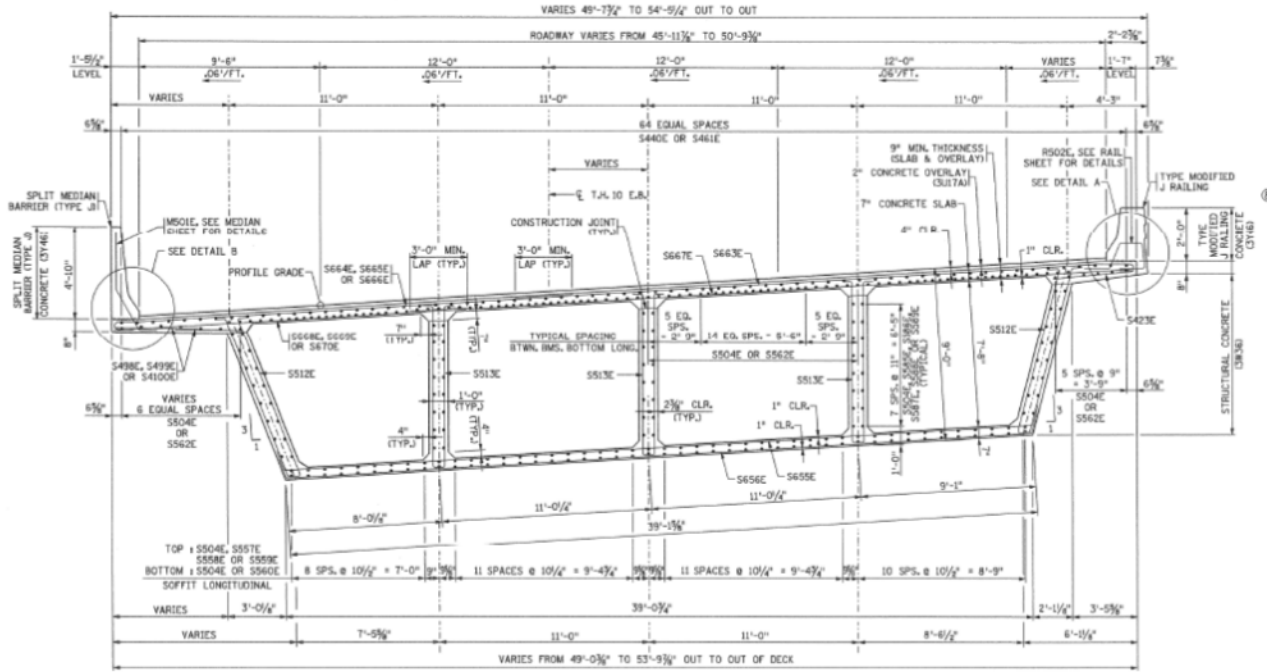

Example Tendon Profile

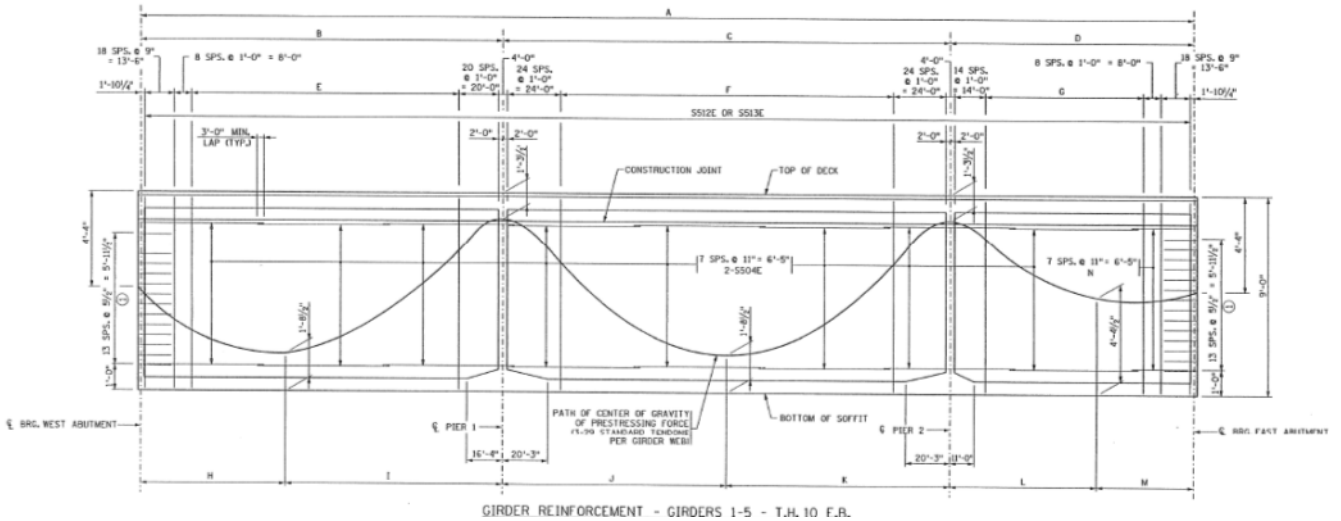

Inspection notes

(focused on PT indicators):

- Deck has 3 sq ft of delamination near east end block
- Deck cracking (2400 linear feet)
- Leaching cracks at coping under deck

Discussion

The 2009 inspection notes do not indicate anything with respect to the PT boxes, but with NBI ratings of 7 for the deck, 8 for the superstructure and 7 for the substructure, a more detailed

visual inspection related to PT elements is warranted. This structure has significant box girder height and thus the PT tendons have a fairly high vertical rise. The high points in this case would be susceptible to a potentially substantial amount of voiding from bleed water collection. The tendons contain 27 strands and this will contribute to bleed as well. Discussions with Mn/DOT personnel indicate that some problems were also encountered on site during grouting and that a ready-mix truck was used for mixing some of the grout (more likely on the westbound structure). This combination of potential problems indicates that a visual and then follow-up invasive spot check at critical locations (high points and end anchors) is warranted for this set of bridges.

Detailed inspection recommendation = 9

(1 lowest to 10 highest)

Bridge 02037 W

District:	Metro	City:	Coon Rapids
Year built:	1997	Bridge Type:	PT box girder
Facility:	US 10 WB	Feature:	University Ave & MN 610
Length:	597 ft	Deck width:	49.21 ft
Last inspection:	9/28/2009	Spans:	4
NBI:	Deck : 7	Super: 8	Sub: 7

Representative Figures



Example Cross Sections

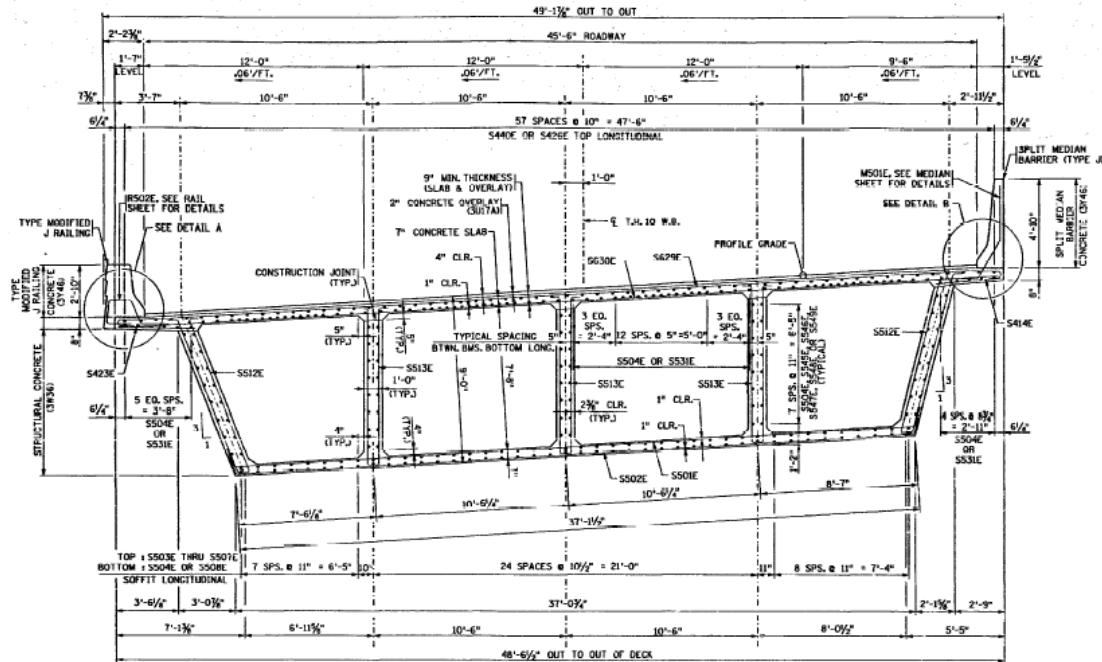

Example Tendon Profile

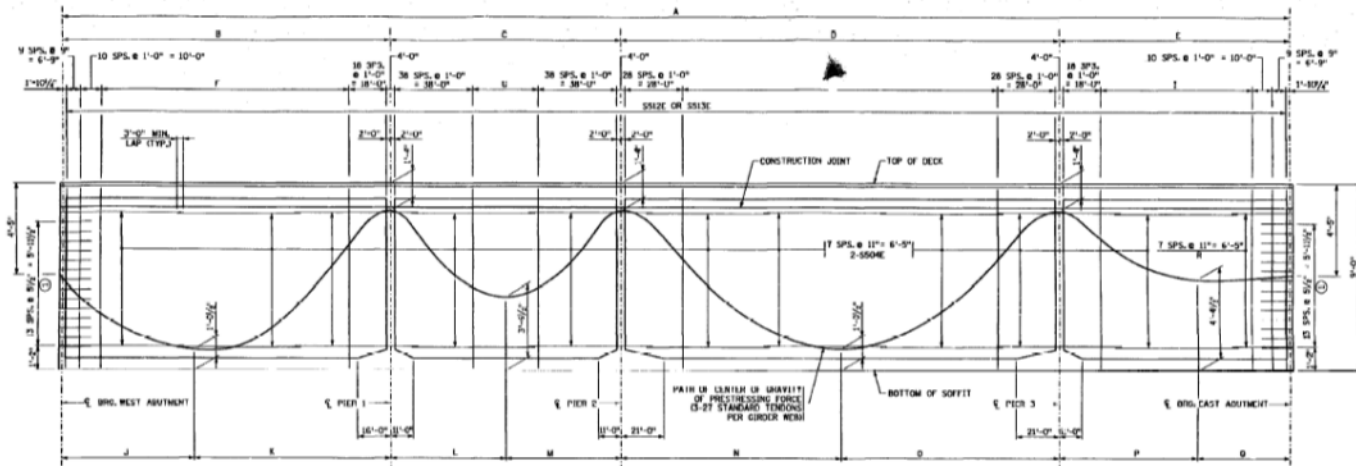

Inspection notes

(focused on PT indicators):

- Deck has 4 sq ft of delamination (2 sq ft spalling) at west end block; 1 sq ft spalling at east end block

Discussion

This is the sister structure to 02037E. Similar concerns exist at tendon high points. No information is given in the 2009 inspection report about the PT boxes. This structure is potentially more of a concern than the eastbound structure due to grouting procedures observed on site by Mn/DOT personnel.

Detailed inspection recommendation = 9
(1 lowest to 10 highest)

Bridge 02044

District:	Metro	City:	Blaine
Year built:	1997	Bridge Type:	PT box girder
Facility:	Pedestrian	Feature:	US 10
Length:	262	Deck width:	13.12
Last inspection:	9/28/2009	Spans:	2
NBI:	Deck : 7	Super: 7	Sub: 7

Representative Figures



Example Cross Sections

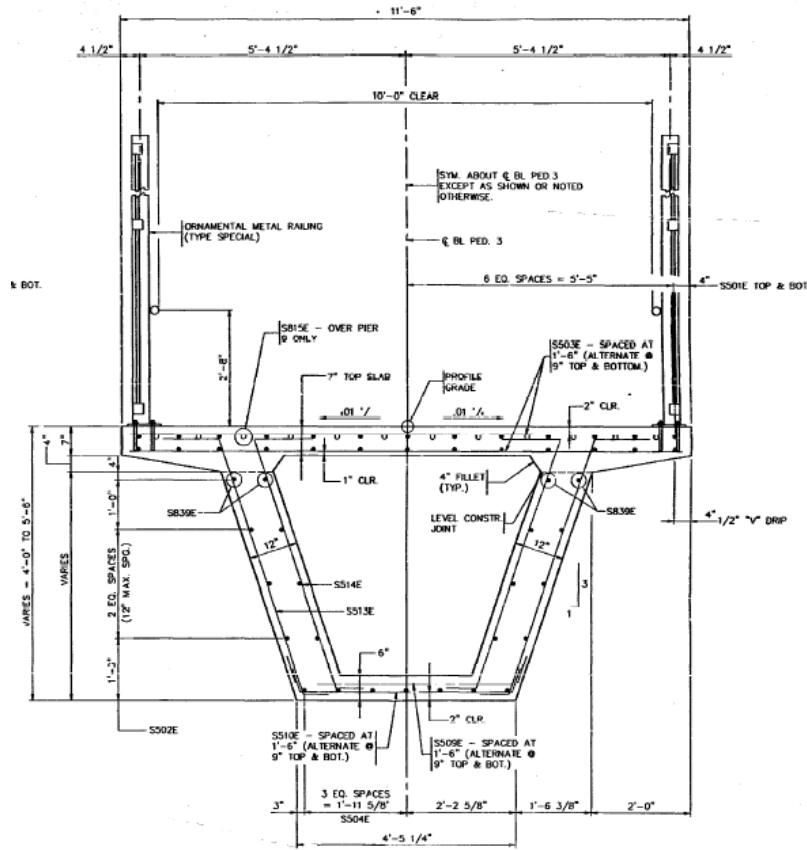

Example Tendon Profile

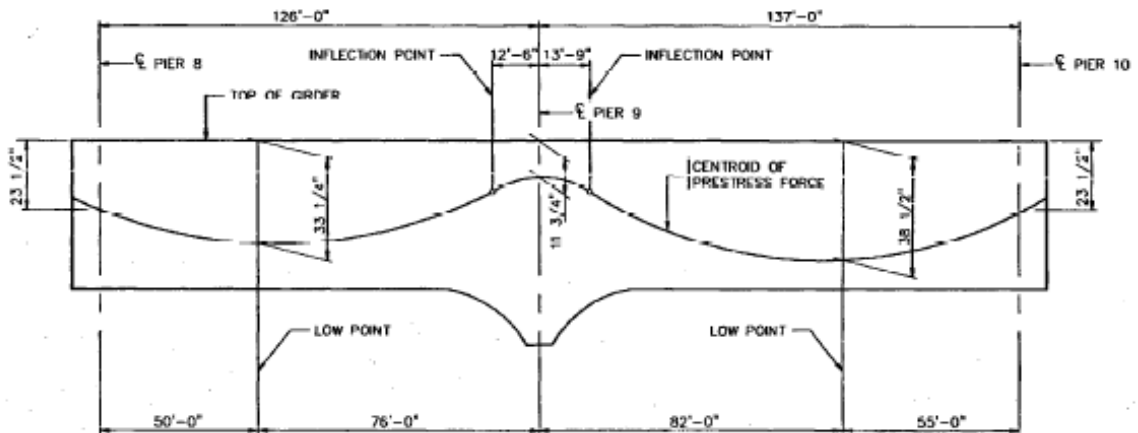

Inspection notes

(focused on PT indicators):

- Pier caps have 50 linear feet of vertical cracking with leaching

- Transverse cracks with leaching on underside

Discussion

The inspection details for this pedestrian bridge indicate primarily cracks with leaching but no other concerns. The vertical cracking in the pier caps seems extensive from the inspection notes, so these should be monitored visually. We do not have access to the pier cap plans so we assume they are not PT. If there are PT, the pier caps should be inspected.

Detailed inspection recommendation = 5

(1 lowest to 10 highest)

Bridge 27194

District:	Metro	City:	Eden Prairie
Year built:	1998	Bridge Type:	PT box girder
Facility:	TH 5 EB	Feature:	US 212 & WB Ramp
Length:	690 ft	Deck width:	45.3 ft
Last inspection:	11/12/2009	Spans:	4
NBI:	Deck : 7	Super: 7	Sub: 7

Representative Figures



Example Cross Sections

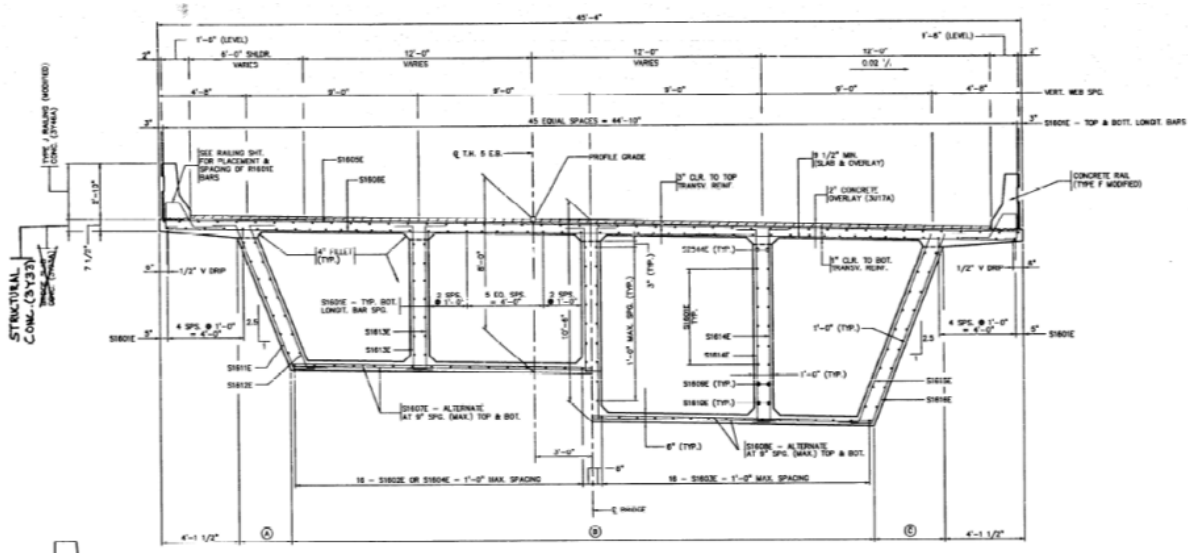

Example Tendon Profile

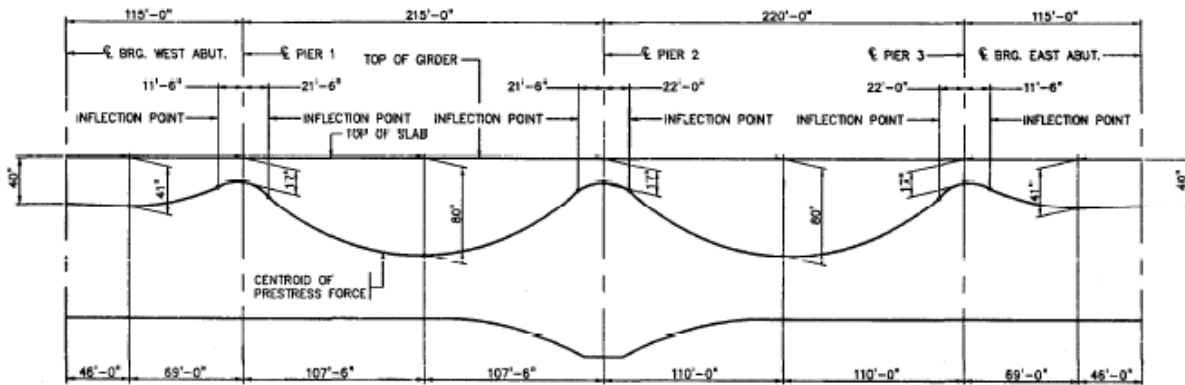

Inspection notes

(focused on PT indicators):

- Deck surface delamination at end block
- Deck joint seal failures
- PT box girder has location with 2 sq ft of cracking and delamination, exposed rebar
- Transverse cracking at pier 1

Discussion

The bridge has a parabolic tendon profile with relatively tall vertical rise, so high points are susceptible to bleed. The tendon size is not available on the provided plans, but larger tendons will have a higher tendency to accentuate bleeding due to the wicking effect of the 7-wire strand. High points and areas near the joint seal failures should be the focus of inspection. The spalled area with exposed rebar should also be inspected for the effect on tendons in that area.

Detailed inspection recommendation = 8

(1 lowest to 10 highest)

Bridge 27217

District:	Metro	City:	Brooklyn Park
Year built:	1998	Bridge Type:	PT box girder
Facility:	TH 252 NB on ramp	Feature:	TH 610
Length:	550 ft	Deck width:	33.1 ft
Last inspection:	10/22/2009	Spans:	4
NBI:	Deck : 7	Super:	7
		Sub:	7

Representative Figures



Example Cross Sections

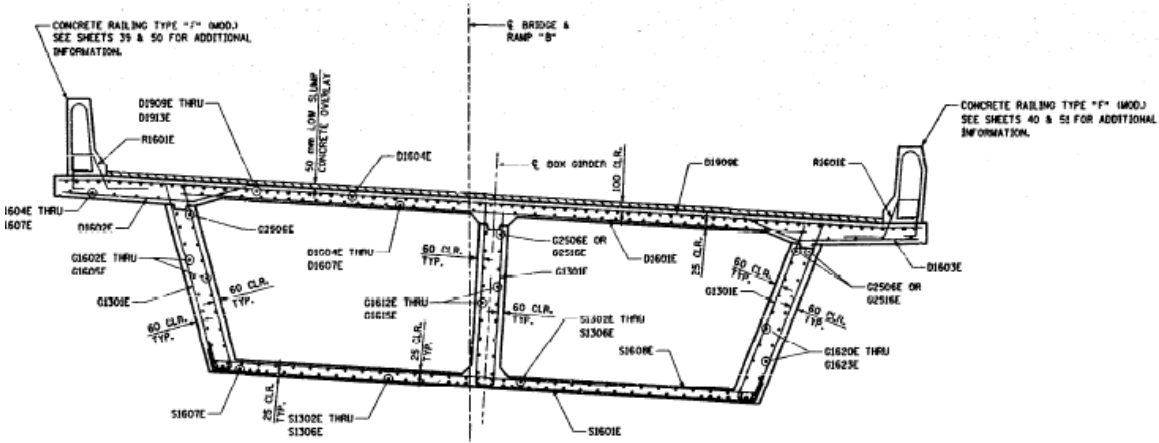

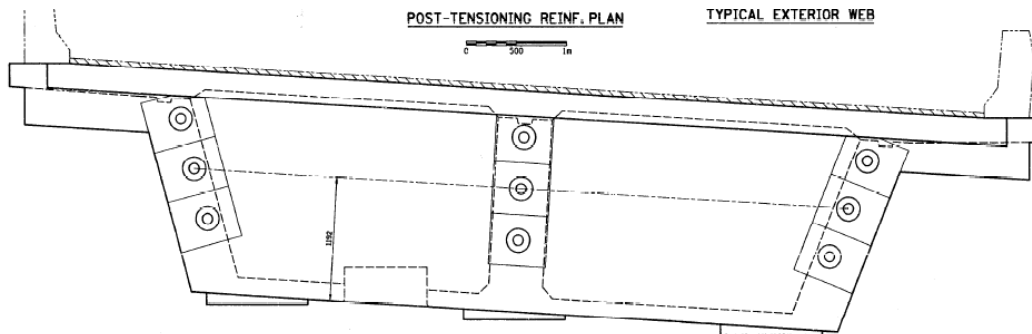

END VIEW OF POST-TENSIONING DETAILS AT ABUTMENT
Example Tendon Profile

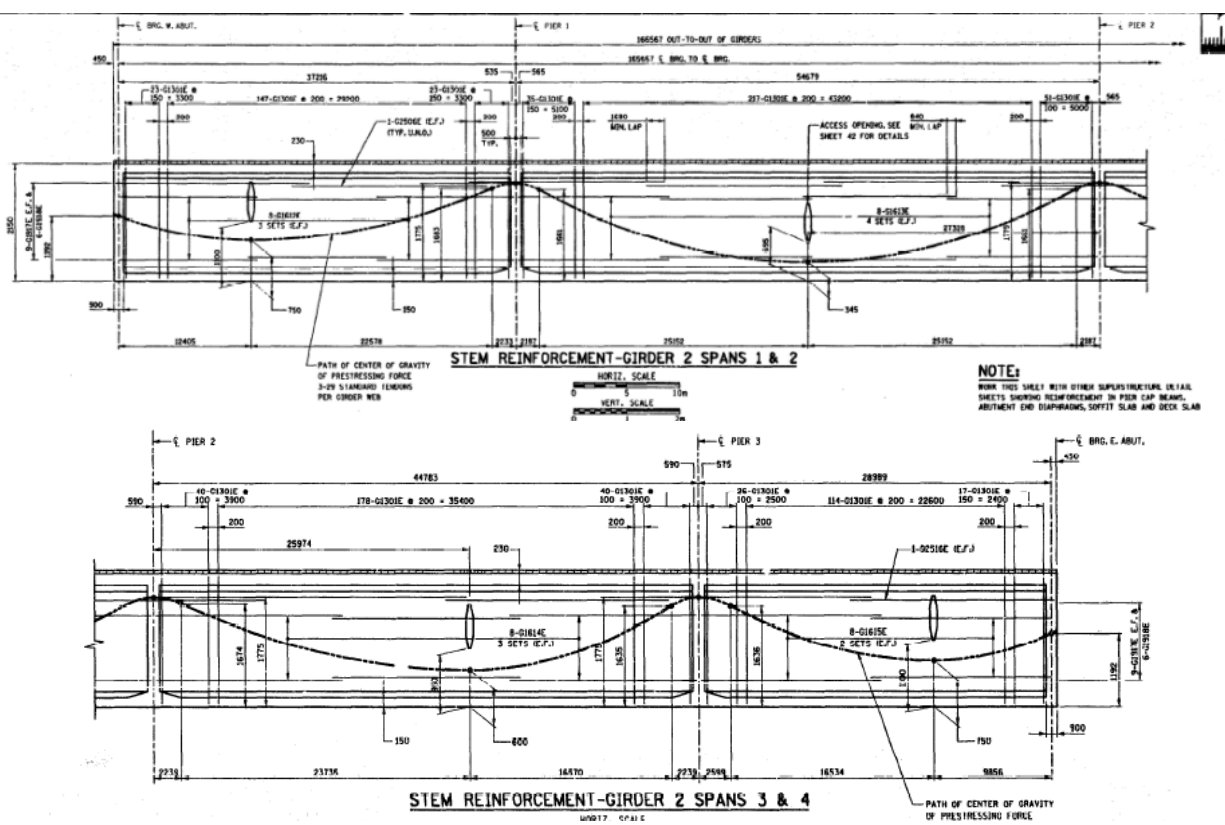

Inspection notes

(focused on PT indicators):

- Deck overlay has 2 sq ft spall at west end block
- Deck has longitudinal and map cracking

Discussion

The 2009 inspection has nothing reported for the box girders.

This bridge has a deep box section with parabolic tendons, so there are potential concerns with voids from bleed. High points should be spot checked for voids and future inspections should include an inspection inside of the box girders.

Detailed inspection recommendation = 8
(1 lowest to 10 highest)

Bridge 27218

District:	Metro	City:	Brooklyn Park
Year built:	1998	Bridge Type:	PT box girder
Facility:	TH 252 SB	Feature:	TH 610
Length:	568 ft	Deck width:	46.6 ft
Last inspection:	11/13/2009	Spans:	4
NBI:	Deck : 7	Super:	8
		Sub:	8

Representative Figures



Example Cross Sections

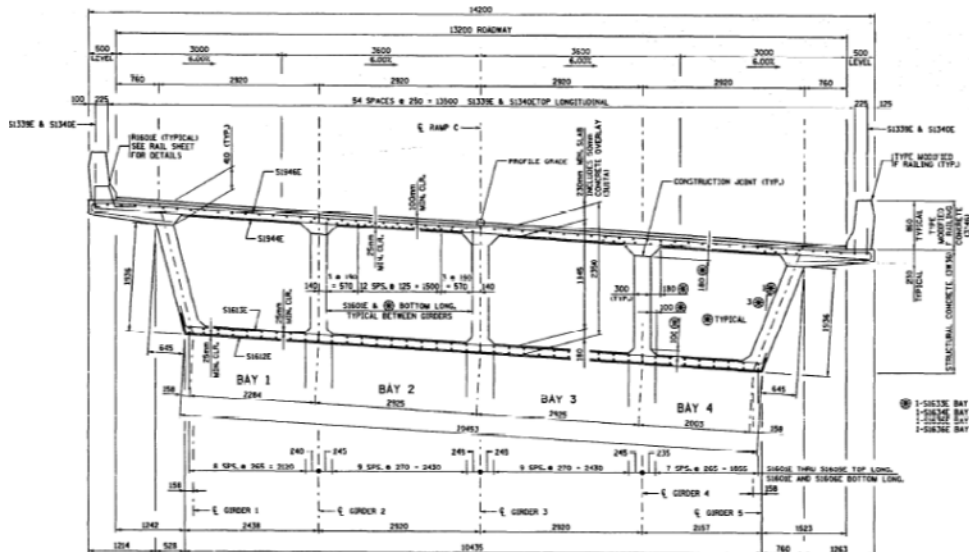

Example Tendon Profile

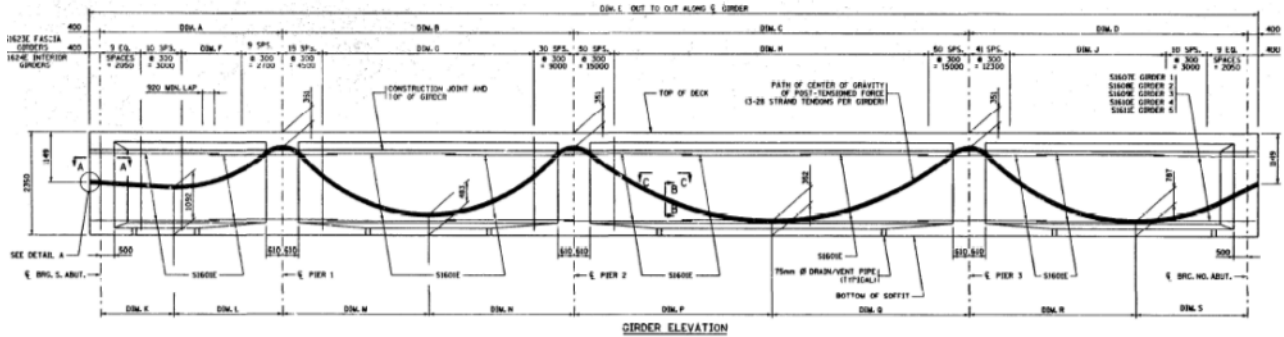

Inspection notes

(focused on PT indicators):

- Nothing related to PT

Discussion

The 2009 inspection notes do not indicate cracking in the deck or girders (even though the NBI deck rating is a 7). The continuous parabolic tendon would be susceptible to bleed at high points and should be spot checked. Since no cracking is noted, there is less likelihood of ingress of moisture or chlorides that would cause tendon corrosion.

Detailed inspection recommendation = 6

(1 lowest to 10 highest)

Bridge 27219

District:	Metro	City:	Brooklyn Park
Year built:	1998	Bridge Type:	PT box girder
Facility:	TH 252 SB	Feature:	TH 610 WB on ramp
Length:	545 ft	Deck width:	46.5 ft
Last inspection:	11/13/2009	Spans:	4
NBI:	Deck : 7	Super: 8	Sub: 8

Representative Figures



Example Cross Sections

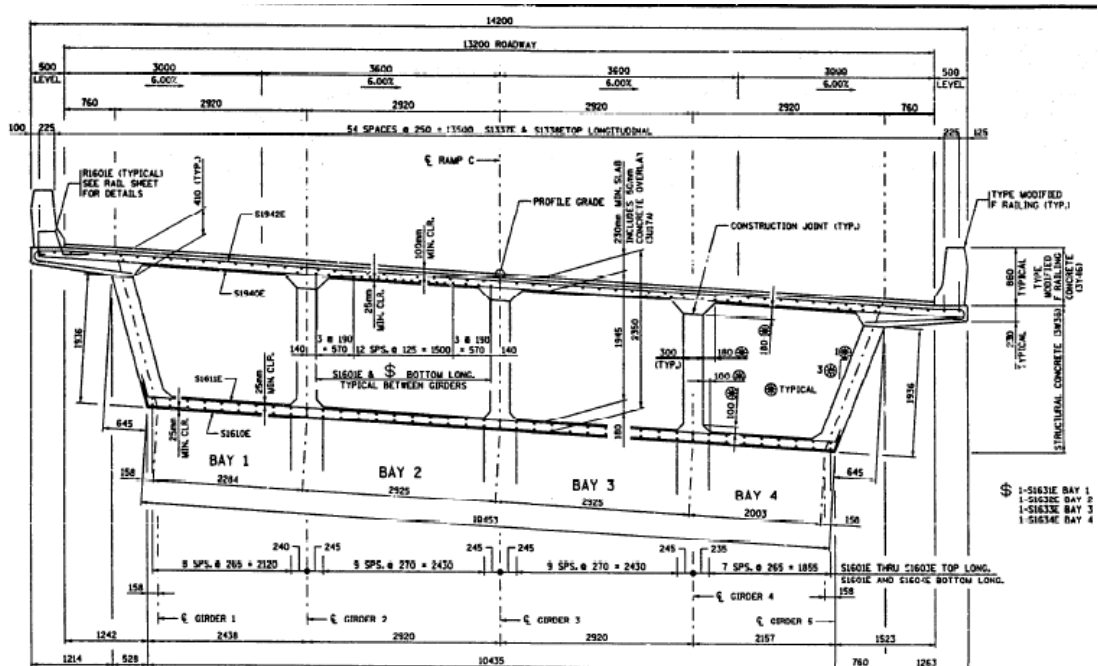

Example Tendon Profile

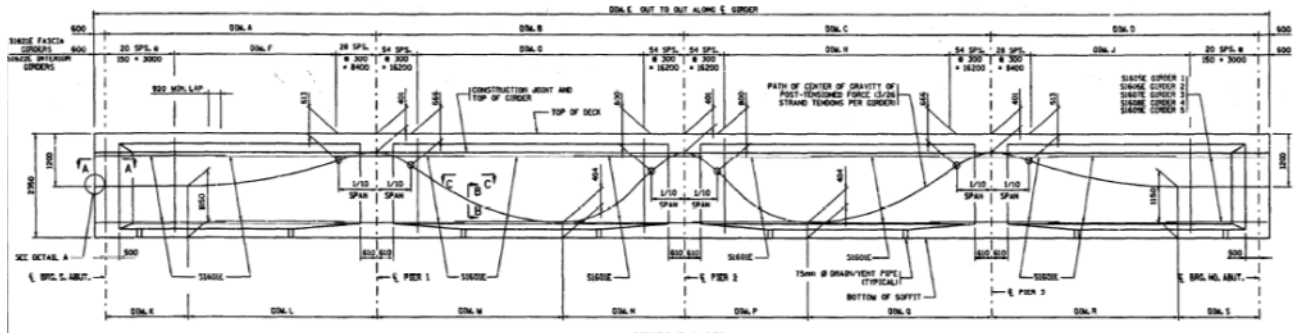

Inspection notes

(focused on PT indicators):

- Nothing related to PT

Discussion

The 2009 inspection notes do not indicate cracking in the deck or girders (as with the previous TH 252 at TH 610 structure). The continuous parabolic tendon would be susceptible to bleed at high points and should be spot checked. Since no cracking is noted, there is less likelihood of ingress of moisture or chlorides that would cause tendon corrosion.

Detailed inspection recommendation = 6

(1 lowest to 10 highest)

Bridge 27220

District:	Metro	City:	Brooklyn Park
Year built:	1998	Bridge Type:	PT box girder
Facility:	Pedestrian	Feature:	TH 610
Length:	694 ft	Deck width:	11.4 ft
Last inspection:	10/22/2009	Spans:	17
NBI:	Deck : 7	Super: 8	Sub: 8

Representative Figures



Example Cross Sections

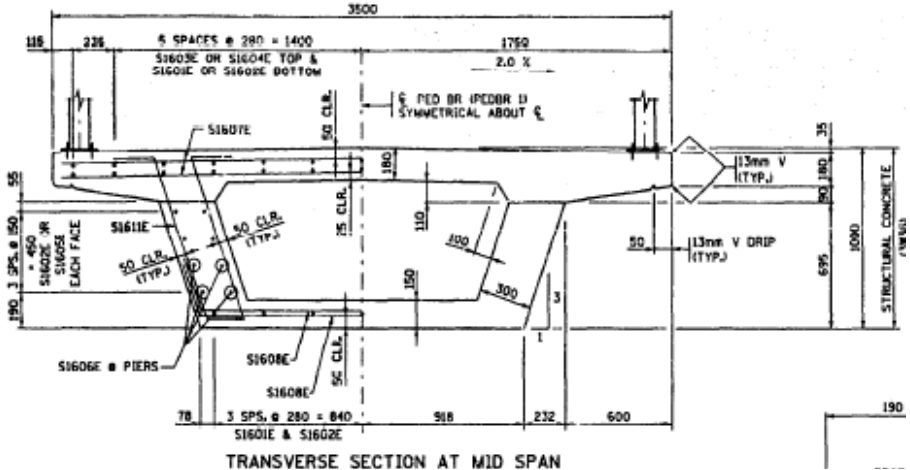

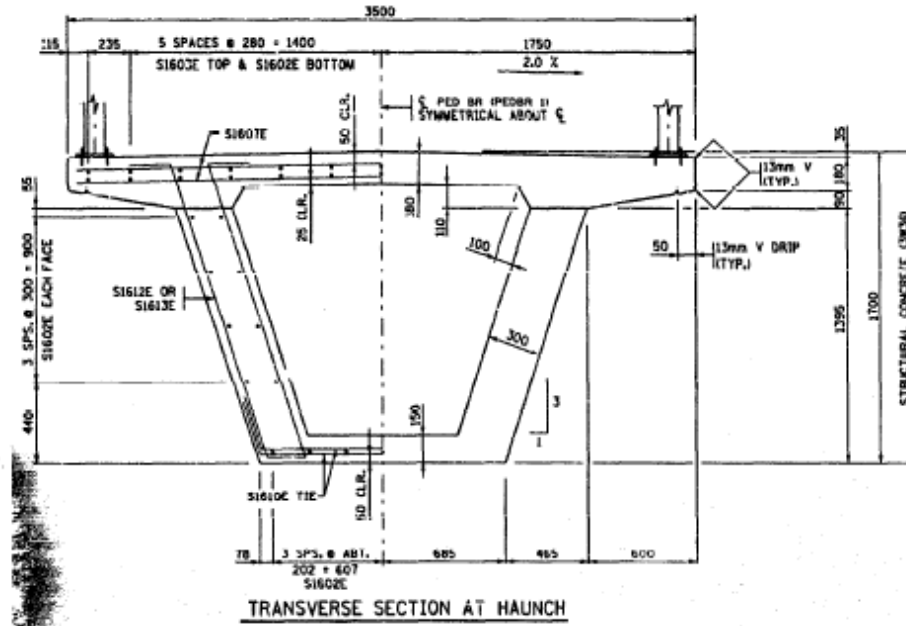

Example Tendon Profile

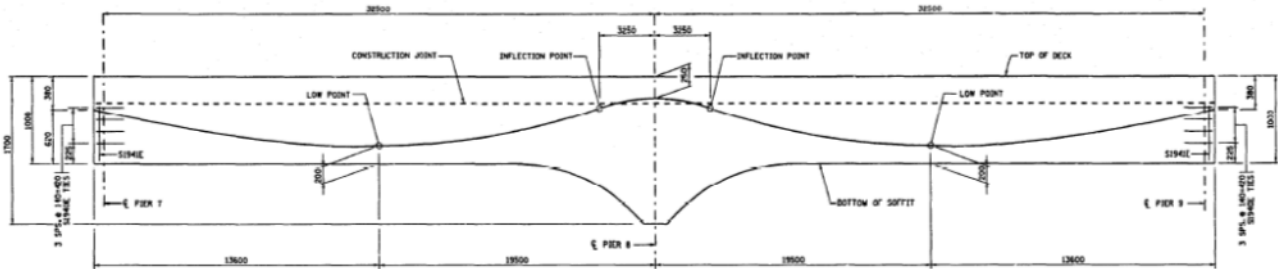

Inspection notes

(focused on PT indicators):

- Transverse and longitudinal deck cracking
- Cracks with leaching on the deck underside at copying (both ramps)

Discussion

This pedestrian bridge has cracking detailed in the 2009 inspection. These locations should be visually monitored for potential corrosion and/or ingress of moisture/chlorides to tendons (particularly in anchor areas). The parabolic profile is susceptible to high point bleeding, but the tendon rise is only moderate for this type of profile.

Detailed inspection recommendation)= 6

(1 lowest to 10 highest)

Bridge 27262 (LRT)

District:	Metro	City:	Minneapolis
Year built:	2002	Bridge Type:	PT box girder
Facility:	LRT	Feature:	TH 55, Ramp, Lake Street
Length:	2072 ft	Deck width:	49.0 ft
Last inspection:	4/29/2008	Spans:	15
NBI:	Deck : 8	Super: 8	Sub: 8

Representative Figures



Example Cross Sections

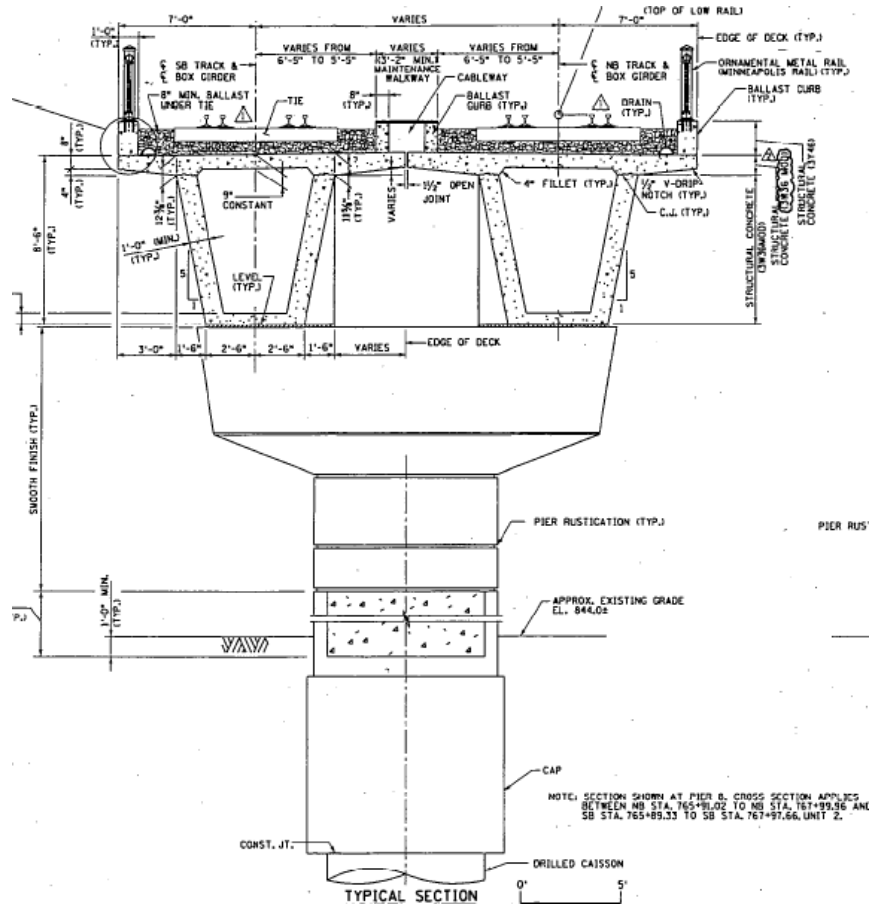

Example Tendon Profile

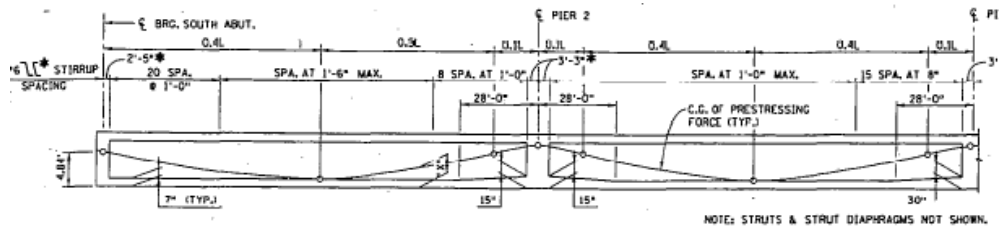

Inspection notes

(focused on PT indicators):

- Void in east girder north of pier #14 (9" deep) with large amount of grout on top of bottom slab that has emanated from the void
- 11" void in span 11 with grout on bottom slab in numerous locations in this area
- Minor cracking with efflorescence in soffit slab
- 4 ft long horizontal cracks around the center web access openings
- Horizontal cracking in W fascia web of the N intermediate diaphragm in span 14

Discussion

This light rail bridge has some warning signs of problems during construction as detailed in the inspection notes. Voiding, grout from the void, and grout on the bottom slab indicate the

possibility of blowouts/leaks during construction and the likelihood that the structure is not fully grouted. These areas should be more thoroughly inspected beyond visual inspection.

Detailed inspection recommendation = 10

(1 lowest to 10 highest)

Bridge 82855 (LRT)

District:	Metro	City:	Newport
Year built:	2003	Bridge Type:	PT box girder
Facility:	TH 494 WB	Feature:	Mississippi R & UP RR
Length:	1892 ft	Deck width:	85.9 ft
Last inspection:	11/9/2009	Spans:	-
NBI:	Deck : 9	Super: 9	Sub: 9

Representative Figures

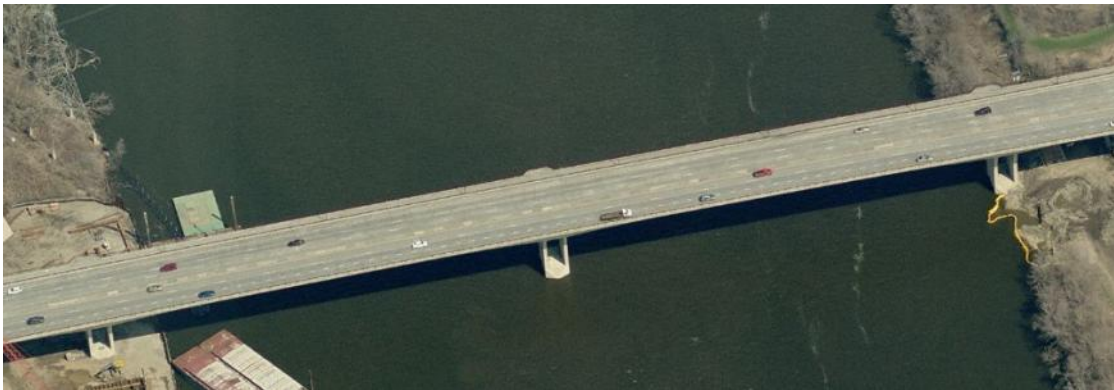

Example Cross Sections

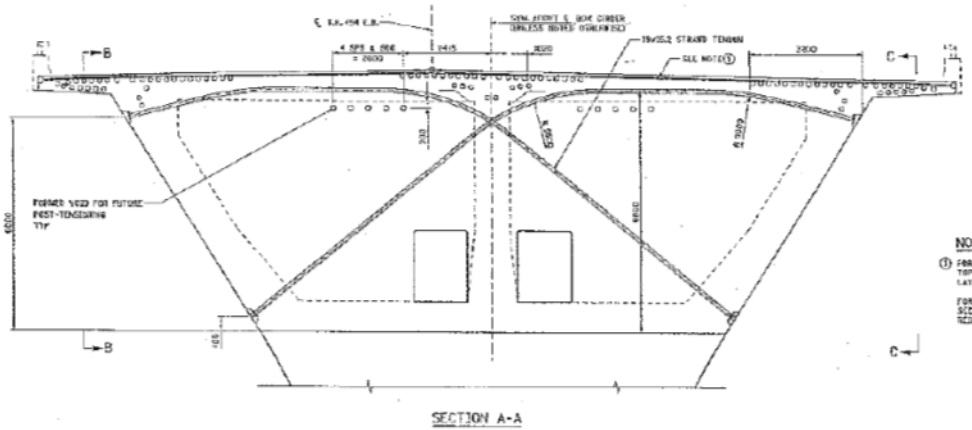

Example Tendon Profile

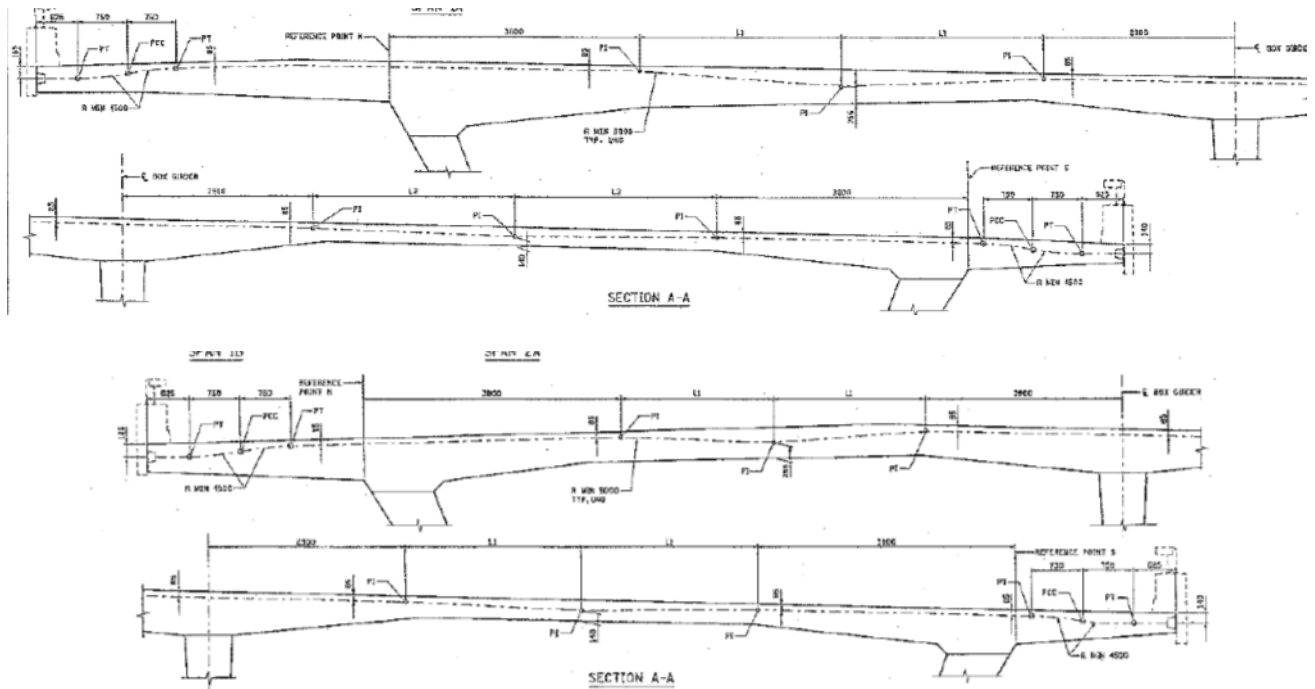

Inspection notes

(focused on PT indicators):

- The 2009 inspection notes indicate that the structure was not yet complete

Discussion

This bridge has a deep box section and includes post-tensioning in the longitudinal direction, transverse top flange (deck), transverse diagonal in diaphragm sections, and in the footings. Inspections for this bridge should include targeted visual inspections (where possible) for all of the PT elements and inspections should include the interior of the box girders. At this time the structure is relatively new and inspection reports for the two sister bridges do not indicate problems, so the recommendation for inspection under this project is low. This bridge was in the pre-2003 inventory based on the construction start, but was not fully completed until 2009.

Detailed inspection recommendation = 3

(1 lowest to 10 highest)

Bridge 82856

District:	Metro	City:	Newport
Year built:	2003	Bridge Type:	PT box girder
Facility:	TH 494 WB	Feature:	Mississippi R & UP RR
Length:	1892 ft	Deck width:	98.7 ft
Last inspection:	8/27/2009	Spans:	-
NBI:	Deck : 8	Super: 8	Sub: 8

Representative Figures

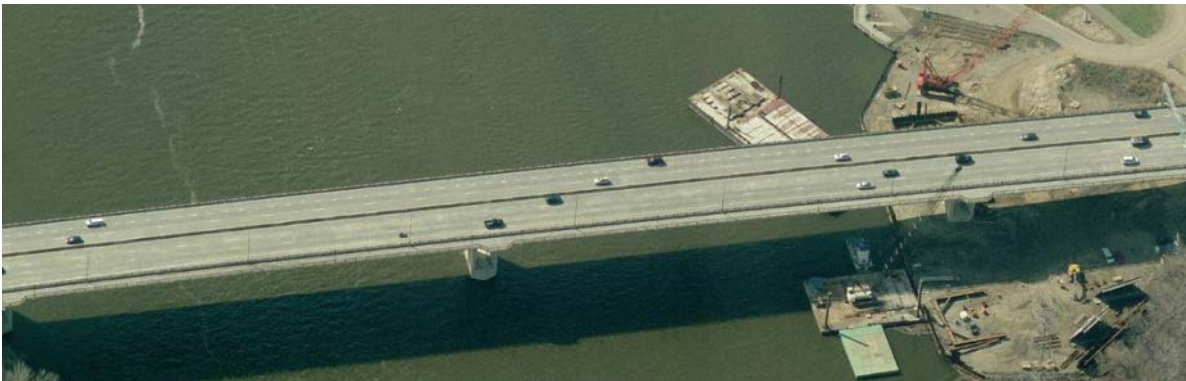

Example Cross Sections

See plans for 82855

Example Tendon Profile

See plans for 82855

Inspection notes

(focused on PT indicators):

- Random cracks in all box girder members
- Deck cracking

Discussion

This bridge (sister structure to 82855) has been open to traffic since 2006. Inspection notes from 2009 indicate cracks in all box girder members. These cracks should be visually inspected with specific focus on their potential cause and then the effect they may have on the durability of the post-tensioning. For this reason, this bridge has been given a higher recommended inspection rating than the sister structure. The visual inspection should include the interior of the boxes and may need to be followed up with more invasive inspection if warranted by the visual inspection.

Detailed inspection recommendation = 7

(1 lowest to 10 highest)

SLAB SPAN BRIDGES
Bridge 95893A

District:	Metro	City:	Minneapolis
Year built:	1986	Bridge Type:	PSTN SD DK Girder
Facility:	5 th St Gar(1 st st)	Feature:	I 394
Length:	336 ft	Deck width:	130 ft
Last inspection:	7/1/2008	Spans:	See Plans
NBI:	Deck : B	Super: B	Sub: B

Representative Figures



Elevation View

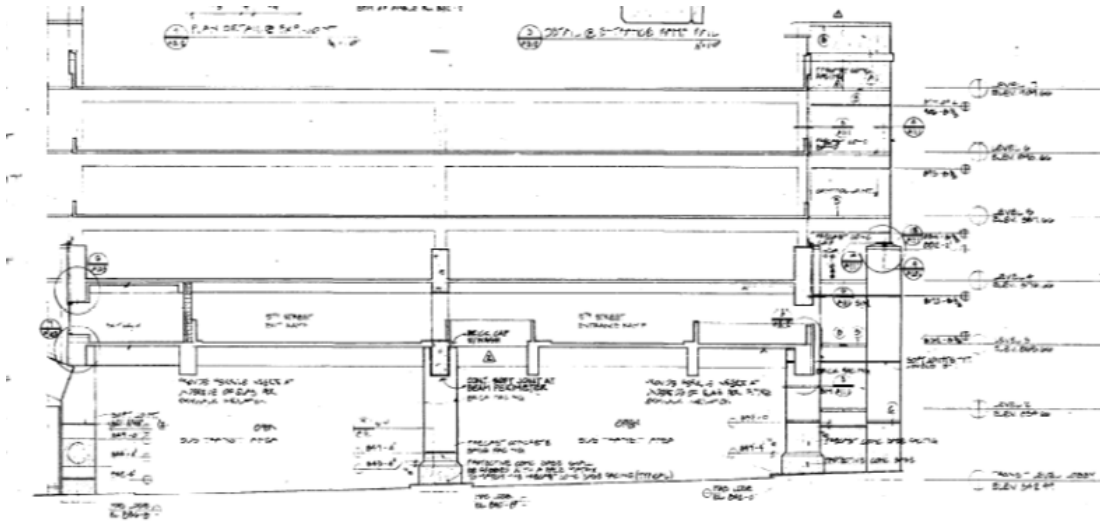

Example Tendon Profile

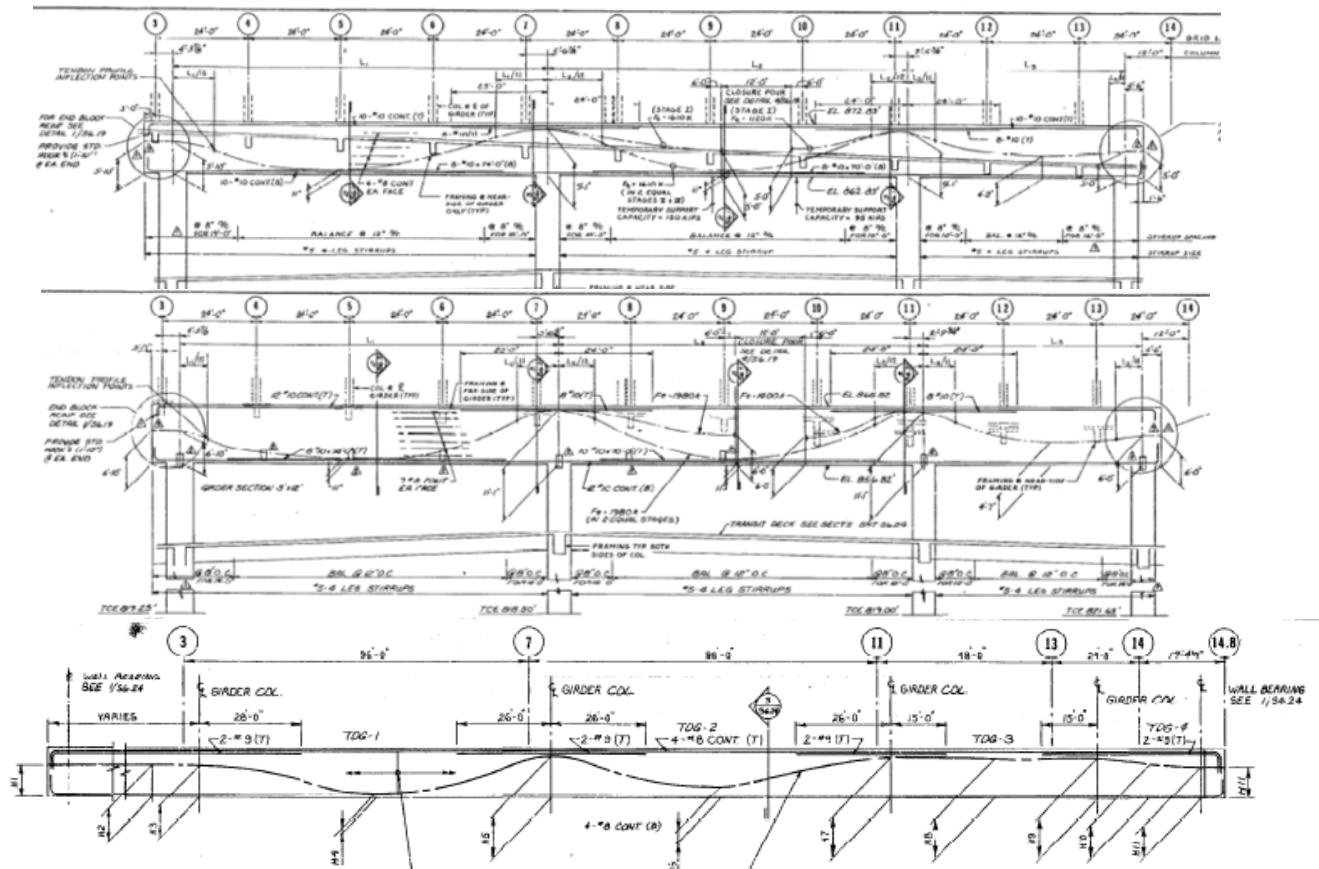

Inspection notes
(focused on PT indicators):

- None related to PT

Discussion

This bridge is part of a parking garage with PT transfer girders. The transfer girders have a parabolic tendon profile, but the vertical rise is moderate to low, so significant voids from bleed are less likely than in other parabolic tendons. The cross-section is rectangular so issues with cracking in shear or bursting cracks near anchorage is minimized compared to a box section.

Detailed inspection recommendation = 3

(1 lowest to 10 highest)

Bridge 27547

District:	Metro	City:	Minneapolis
Year built:	1970	Bridge Type:	PSTN SD SLAB SPAN
Facility:	Chicago Ave	Feature:	Minnehaha Creek
Length:	53 ft	Deck width:	67 ft
Last inspection:	6/30/2009	Spans:	1
NBI:	Deck : 7	Super: 7	Sub: 8

Representative Figures

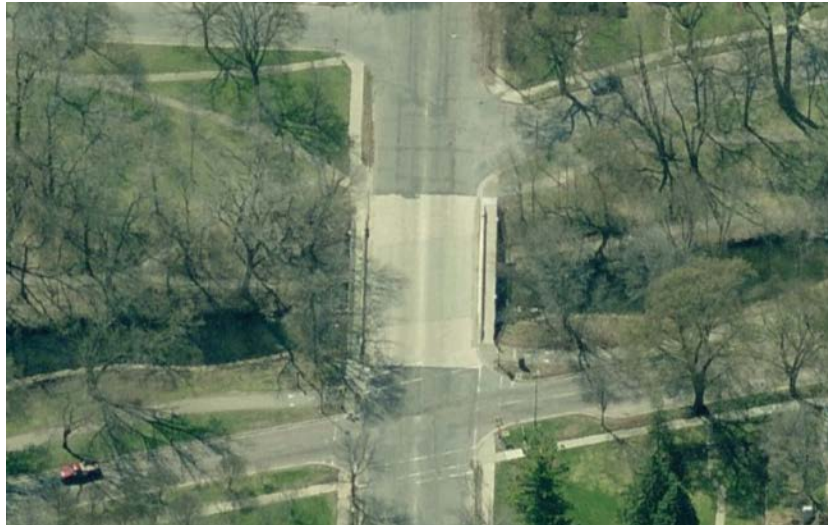

Example Cross Sections

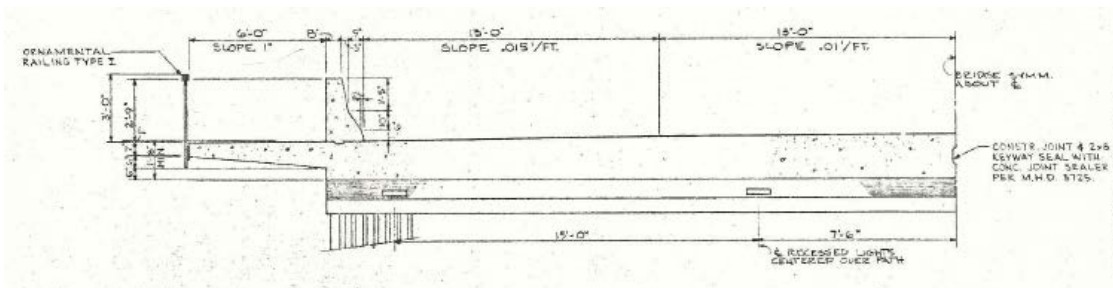

Example Tendon Profile

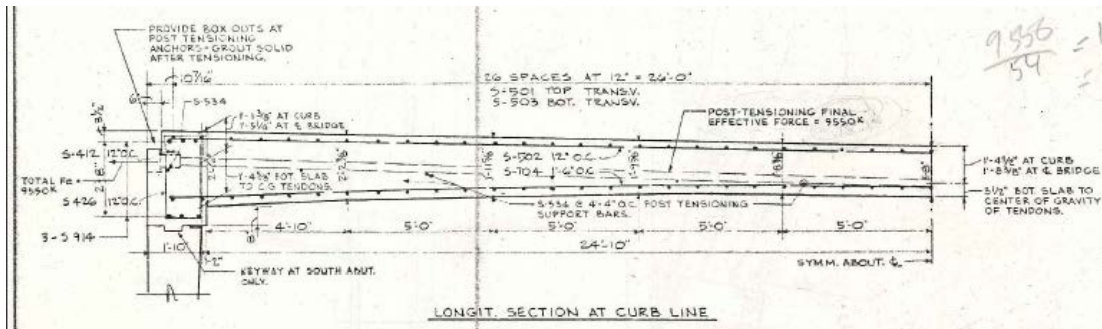

Inspection notes

(focused on PT indicators):

- Deck surface has minor uniform scaled, 3 sealed longitudinal full depth cracks, and some small spalls at the longitudinal joint line
- Underside of deck has a fine longitudinal cracks with efflorescence
- Underside has some spall at the outside edges with rebar exposed

Discussion

This PT slab bridge has cracking as would be expected in a bridge of this age. The tendon profile has little vertical rise, so bleed problems should be minimal. The end anchorage details should be visually inspected for signs of corrosion. This is the oldest PT bridge listed in the Mn/DOT inventory, so is of interest for brief visual inspection under this contract from that perspective.

Detailed inspection recommendation = 4

(1 lowest to 10 highest)

Bridge 52009

District:	7	City:	North Mankato
Year built:	1985	Bridge Type:	PSTN SD SLB SPAN
Facility:	TH 860D	Feature:	US 169
Length:	145 ft	Deck width:	106.3 ft
Last inspection:	8/3/2009	Spans:	2
NBI:	Deck : 7	Super: 7	Sub: 7

Representative Figures



Example Cross Sections

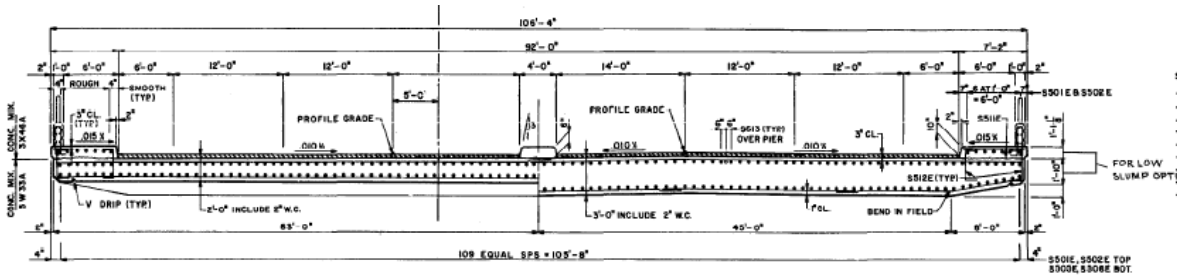

Example Tendon Profile

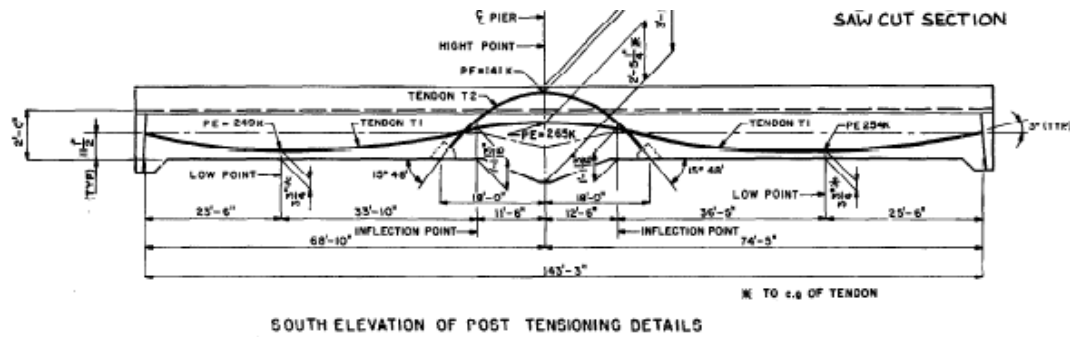

Inspection notes

(focused on PT indicators):

- Deck cracking and experimental patch cracking/failing
- Poured deck joints have failed in some locations; cracking and spalling

Discussion

This PT slab bridge has some relatively large tendons, but does not have a vertical rise that would indicate the likelihood of large grouting voids in the tendons. The bridge has additional PT tendons at the intermediate pier location that runs in a sharper radius completely through the superstructure (with anchorage below the deck). The amount cracking and spalling indicated in the inspection reports, particularly at joints may be cause for concern due to potential ingress of moisture and chlorides to the tendons. A visual inspection concentrating on these areas as they relate to the tendon profile is recommended, with particular focus on anchorage areas and on the intermediate pier tendon.

Detailed inspection recommendation = 7

(1 lowest to 10 highest)

Bridge 94174

District:	4	City:	Moorhead
Year built:	1989	Bridge Type:	PSTN SD SLB SPAN
Facility:	Parking Deck	Feature:	MSAS 115 (1 st Ave N)
Length:	266 ft	Deck width:	110 ft
Last inspection:	9/29/2009	Spans:	-
NBI:	Deck : 7	Super:	7
		Sub:	8

Inspection notes

(focused on PT indicators):

- Spalling and cracking on deck surface
- Hairline cracking on underside of deck and 2'x2'x3" delimited area over EB traffic

Discussion

This bridge is a parking deck with a PT slab span, and has been included since it shows up in the PT bridge inventory list. No plans were available. The inspection primarily details cracking and spalling. These areas should be visually inspected in relation to the location of PT tendons and anchorage.

Detailed inspection recommendation = 4

(1 lowest to 10 highest)

Bridge 20004

District:	6	City:	Mantorville
Year built:	1996	Bridge Type:	PSTN SD SLB SPAN
Facility:	TH 57	Feature:	S BR MID FK Zumbro R
Length:	178 ft	Deck width:	52.8 ft
Last inspection:	6/24/2009	Spans:	3
NBI:	Deck : 7	Super: 7	Sub: 7

Representative Figures



Example Cross Section

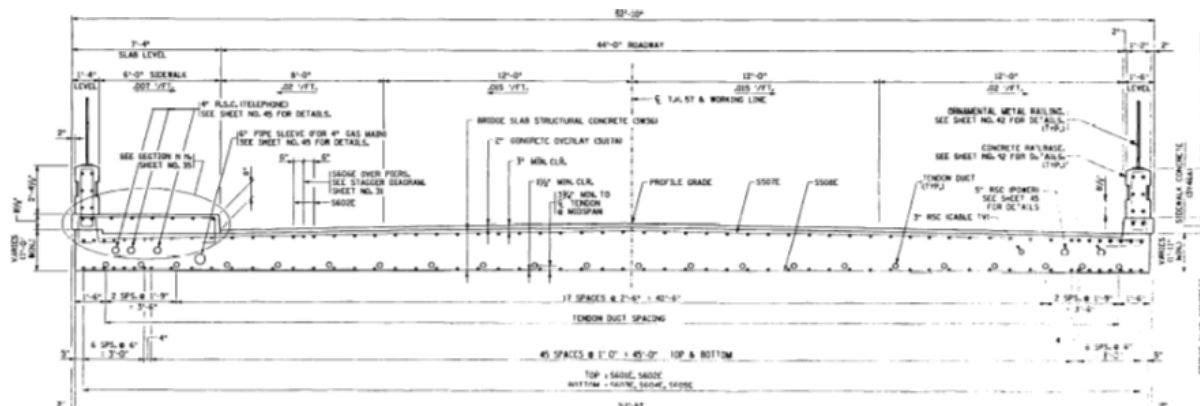

Inspection notes

(focused on PT indicators):

- 2 longitudinal cracks on underside of concrete deck extending out from both abutments near centerline

Discussion

As detailed in the inspection notes, this PT slab bridge appears to be in good condition. Visual inspection near cracking locations as related to PT is recommended along with visual inspection of anchorage areas where possible.

Detailed inspection recommendation = 3
(1 lowest to 10 highest)

Bridge 27A32

District:	Metro	City:	Minneapolis
Year built:	1997	Bridge Type:	PSTN SD SLB SPAN
Facility:	4 th Ave S	Feature:	Midtown Greenway
Length:	197 ft	Deck width:	58.8 ft
Last inspection:	5/27/2009	Spans:	-
NBI:	Deck : 8	Super: 8	Sub: 8

Representative Figures

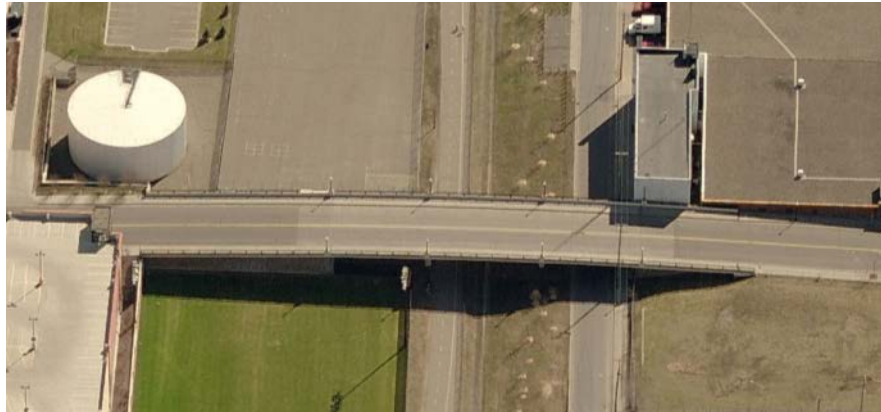

Inspection notes

(focused on PT indicators):

- Fine transverse and longitudinal cracking in overlay; 2445 linear feet of deck cracking (year 2000)

Discussion

This PT slab bridge appears to be in good condition from the inspection notes. Plans were not available, but this type of bridge is less susceptible to grouting problems and bleed, so there is less concern related to the PT components of this structure than of other structure types.

Detailed inspection recommendation = 3

(1 lowest to 10 highest)

Bridge 27192

District: Metro Year built: 2000 Facility: Minnehaha PKWY Length: 112 ft Last inspection: 8/13/2009 NBI: Deck : 8	City: Minneapolis Bridge Type: PSTN SD SLB SPAN Feature: Minnehaha Creek Deck width: 49.7 ft Spans: 2 Super: 8 Sub: 8
--	--

Representative Figures



Example Cross Section

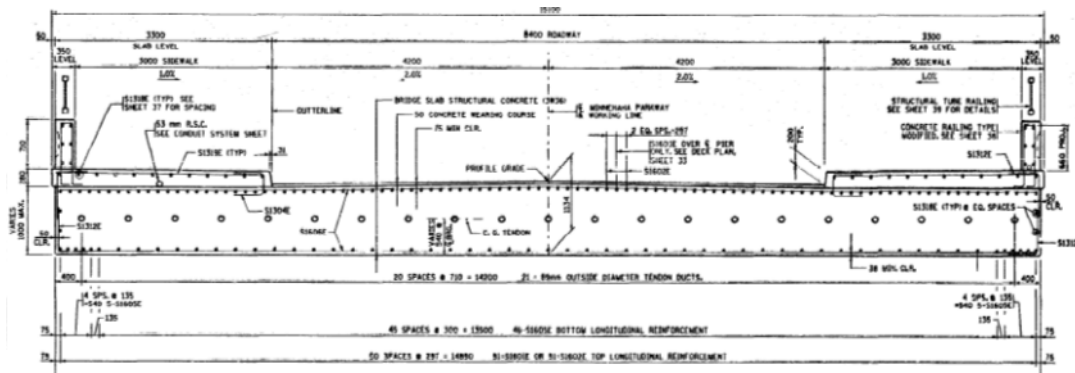

Inspection notes

(focused on PT indicators):

- Fine sized map cracking in deck

Discussion

This is a relatively new PT slab bridge with no indications of PT related problems highlighted in the inspection report.

Detailed inspection recommendation = 2
(1 lowest to 10 highest)

Bridge 54544

District:	2	City:	Halstad
Year built:	2000	Bridge Type:	PSTN SD SLB SPAN
Facility:	CR 129	Feature:	Marsh River
Length:	183 ft	Deck width:	32 ft
Last inspection:	10/23/2009	Spans:	-
NBI:	Deck : 8	Super: 8	Sub: 8

Inspection notes

(focused on PT indicators):

- None related to PT

Discussion

Not enough information is available for this bridge to make in-depth inspection recommendations. The inspection report does not indicate problems related to PT. The recommendation inspection rating is low based on bridge type, age and inspection notes.

Detailed inspection recommendation = 2

(1 lowest to 10 highest)

Bridge 27A58

District:	Metro	City:	Minnetonka
Year built:	2000	Bridge Type:	PSTN SD SLB SPAN
Facility:	CSAH 101	Feature:	Grays Bay Channel
Length:	261 ft	Deck width:	44.2 ft
Last inspection:	6/25/2008	Spans:	4
NBI:	Deck : 8	Super: 8	Sub: 8

Representative Figures

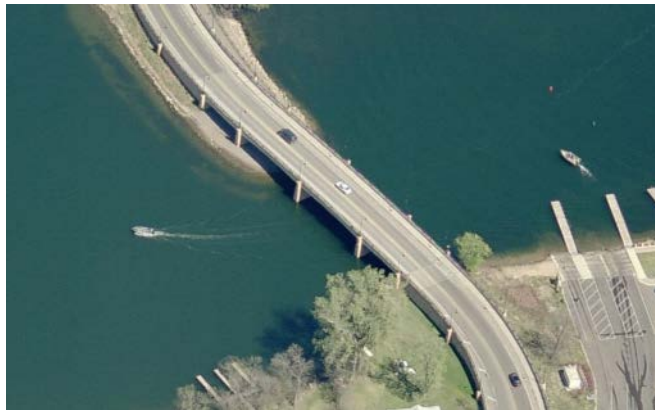

Example Cross Sections

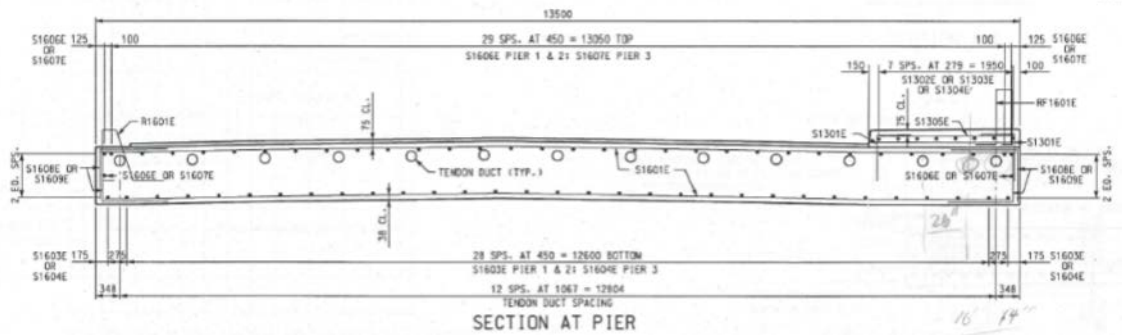

Example Tendon Profile

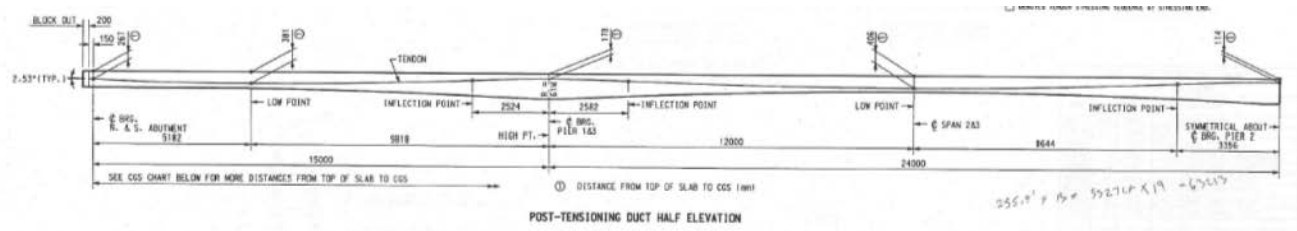

Inspection notes

(focused on PT indicators):

- Some fine transverse and longitudinal cracks in overlay
- Fine longitudinal cracks in underside of slab at centerline in all spans
- Minor areas of honeycombing in the underside of the N span

Discussion

This PT slab span has some cracking and honeycombing on the underside that should be visually inspected in relation to the location of PT tendons and PT anchorage.

Detailed inspection recommendation = 5

(1 lowest to 10 highest)

BEAM SPAN BRIDGES (SPliced GIRDER)

Bridge 70037

District:	Metro	City:	Shakopee
Year built:	1994	Bridge Type:	PSTN SD BM SPAN
Facility:	US 169 EB	Feature:	MSAS 131
Length:	180 ft	Deck width:	44.2 ft
Last inspection:	7/16/2009	Spans:	1
NBI:	Deck : 7	Super: 7	Sub: 7

Representative Figures



Example Cross Sections

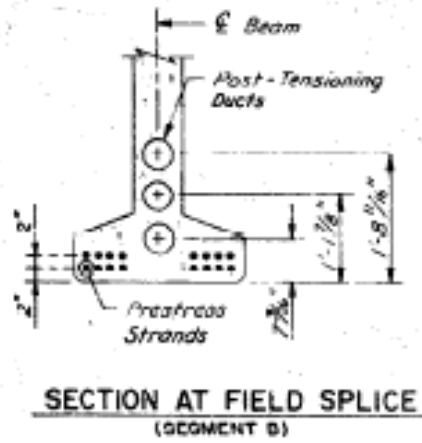
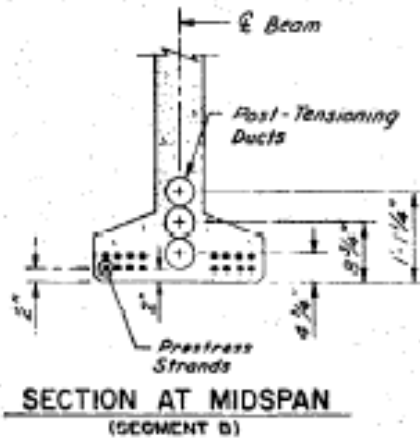
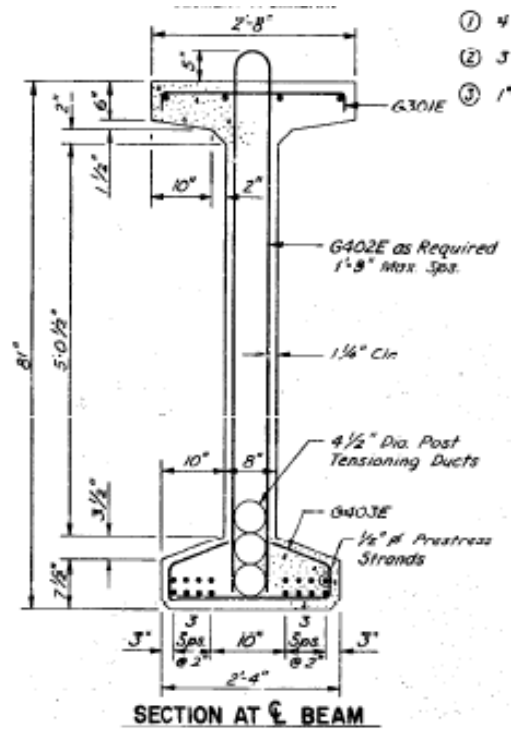

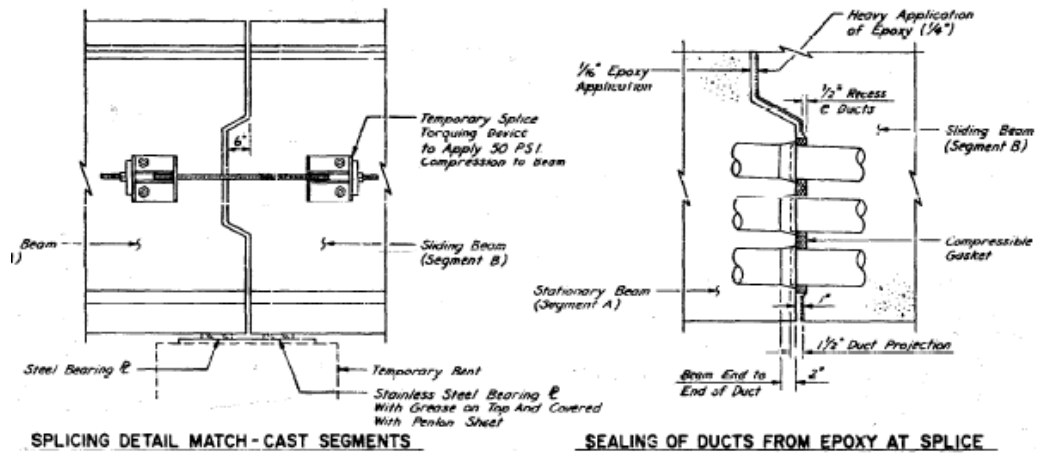

Example Tendon Profile

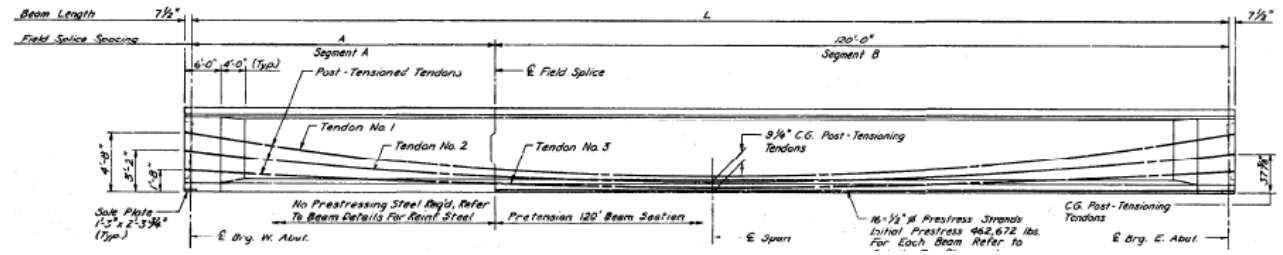

Inspection notes

(focused on PT indicators):

- Overlay delamination and scaling near end block (not likely to be related to PT for this type of system)
- Joint failures

Discussion

This spliced PT girder bridge has no problems directly related to the PT girders indicated in the 2009 inspection report. However, due to the relatively few number of spliced girder bridges in MN (and the US in general), visual inspection of the splices is of interest. The girder depth is considerable, so bleed potential at high points is closer to that of a box girder bridge.

Detailed inspection recommendation = 7 (spliced PT)

(1 lowest to 10 highest)

Bridge 70038

District:	Metro	City:	Shakopee
Year built:	1994	Bridge Type:	PSTN SD BM SPAN
Facility:	US 169 WB	Feature:	MSAS 131
Length:	180 ft	Deck width:	46.5 ft
Last inspection:	7/16/2009	Spans:	1
NBI:	Deck : 7	Super:	7
		Sub:	7

Representative Figures



Example Cross Sections

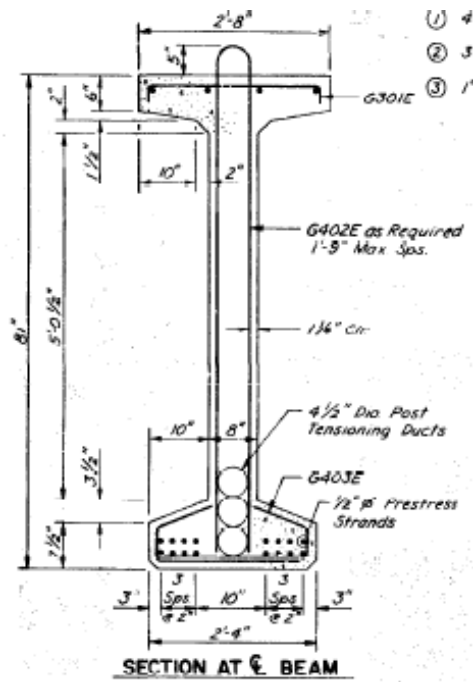

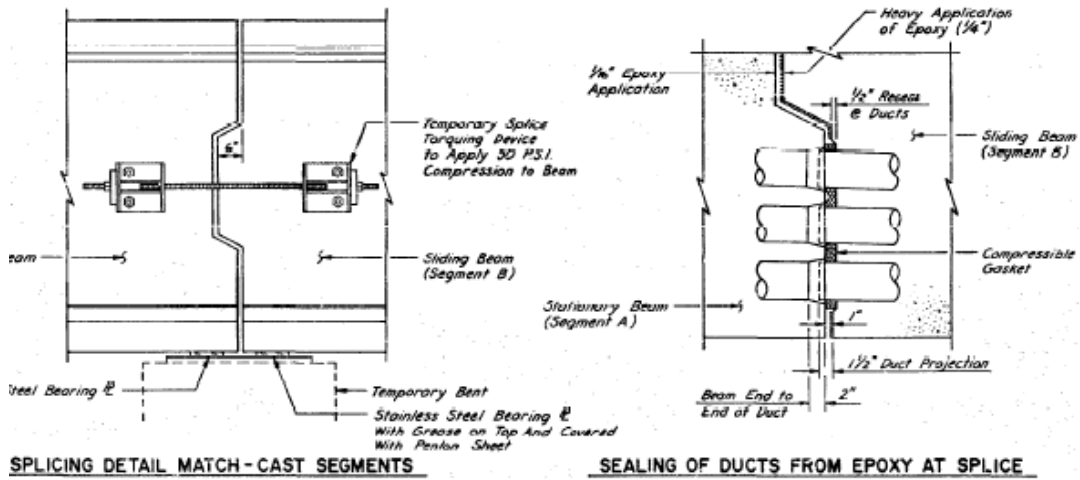

Example Tendon Profile

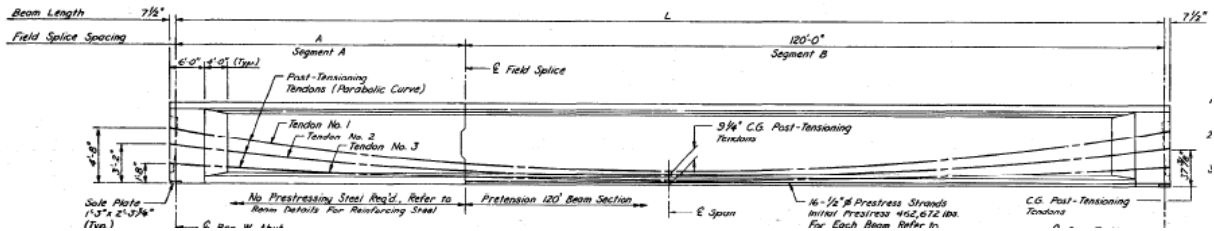

Inspection notes

(focused on PT indicators):

- Overlay delamination and scaling near end block (not likely to be related to PT for this type of system)
- Joint failures

Discussion

See discussion under previous sister structure (70037).

Detailed inspection recommendation = 7 (spliced PT)

(1 lowest to 10 highest)

PT CAP BRIDGES
Bridge 9030 (Blatnik)

District:	1	City:	Duluth
Year built:	1992	Bridge Type:	CSTL High TRUSS
Facility:	I 535	Feature:	St Louis R, RR, Street
Length:	7980 ft	Deck width:	63.7 (varies)
Last inspection:	7/29/2009	Spans:	23
NBI:	Deck : 6	Super: 5	Sub: 6

Representative Figures



Plans reviewed but not included in this report (non-public data)

Inspection notes

(focused on PT indicators):

- PT pier caps had shrinkage cracking that was repaired shortly after construction; nearly identical cracks visible on each pier cap

Discussion

The PT components in this bridge are the PT pier caps. The inspection notes do not indicate any problem areas related to the PT other than the recorded cracking. End anchorage protection should be visually inspected during routine inspections. The end protection for the anchorages as shown in the plans indicate good protection. Plastic end caps are recommended for current construction, but were not typically used at the time of this construction. Metallic caps (that were typically removed) were often used. Indications of cracking, efflorescence and/or rust staining would be indicators of the need for a more detailed inspection. The overall recommendation for inspection of this bridge related to PT is low, however it has been given an “8” based on the reported cracking in the piers. A visual inspection should be done on this bridge under this project contract specific to the PT pier caps.

Detailed inspection recommendation = 8

(1 lowest to 10 highest)

Bridge 9350 (Dartmouth)

District:	Metro	City:	Minneapolis
Year built:	1994	Bridge Type:	CSTL BM SPAN
Facility:	I 94	Feature:	Mississippi R, Ramp
Length:	1001 ft	Deck width:	141.3 (varies)
Last inspection:	10/8/2009	Spans:	6
NBI:	Deck : 7	Super: 6	Sub: 7

Representative Figures



Plans reviewed but not included in this report (non-public data)

Inspection notes

(focused on PT indicators):

- PT caps added in 1995 (river piers #3, 4, 5); cracks and leaching in #5

Discussion

This bridge was originally constructed in 1963 with PT bent caps as part of reconstruction in 1994-1995. The combination of elevation and transverse profile changes in the tendons, cored holes for tendons into existing columns, and importance of end anchorage coverage make this a bridge a good target for a more detailed inspection.

Detailed inspection recommendation = 9

(1 lowest to 10 highest)

Summary and Recommendations

Table 1 on the following page summarizes the bridge inspection recommendations from high (most in need of inspection under this contract) to low. The contract indicates inspection of 3-5 bridges. In order to provide the most efficient and thorough inspection of the bridges that are most critical, a larger group of bridges is recommended for visual inspection by the Principal Investigator (Andrea Schokker) accompanied by Mn/DOT personnel for access to the bridges. The external inspection consultant, VSL, will then inspect a select set of bridges during the week of July 25th, 2011, as prioritized by the visual inspections by Dr. Schokker during the summer of 2011.

The bridges recommended for visual inspection under this contract are chosen as the bridges with inspection recommendations between 8 and 10. This is a total of 10 bridges, or 8 locations (2 are sets of sister structures). Additionally, the spliced girder bridge and the oldest slab span bridge are also of interest as representatives of their specific structure type. This adds 3 more structures (2 locations) to the list for visual inspection. The final list of 10 locations for visual inspection are outlined with a black box in the table and are included in table 2.

Table 1. Bridges in Order of Recommended Inspection

Bridge #	Facility	Feature	Year Built	Inspection Recommendation
27611	PLYMOUTH AVE	MISSISSIPPI RIVER	1980	10
27262	LRT	TH 55, RAMP, & LAKE ST	2002	10
02037E	US 10 EB	University Ave & MN 610	1997	9
02037W	US 10 WB	University Ave & MN 610	1997	9
9350	I-94	Mississippi R , Ramp	1994	9
27719	LYNDALE AVE N	SHINGLE CREEK	1982	8
69818N	I 35 NB	SL&LC RR & TH 194 NB	1985	8
69818S	I 35 SB	SL&LC RR & TH 194 NB	1985	8
02034	US 10 EB On Ramp	MN 47 SB	1996	8
9030	Blatnick (I-535)	St. Louis R, RR, Street	1992	8
27194	TH 5 EB	US 212 & WB on ramp	1998	8
27217	TH 252 NB on ramp	TH 610	1998	8
27593	34TH AVE S	MINNEHAHA CREEK	1974	7
27264	LRT	TH 55, 62 & RAMP	2003	7
82856	TH 494 WB	Mississippi R & UP RR	2003	7
52009	TH 860D	US 169	1985	7
70037	US 169 EB	MSAS 131	1994	7
70038	US 169 WB	MSAS 131	1994	7
62555A	MSAS 235(NB WAB S)	MISS R & RR & STR'S	1996	6
62555B	MSAS 235(SB WAB S)	MISS R & RR & STR'S	1996	6
27218	TH 252 SB	TH 610	1998	6
27219	TH 252 SB	TH 610 WB on ramp	1998	6
27220	PEDESTRIAN	TH 610	1998	6
27581	FREEWAY BLVD	SHINGLE CREEK	1974	5
02044	Pedestrian	US 10	1997	5
27A58	CSAH 101	Grays Bay Channel	2000	5
27622	SB SHIN CRK P(109)	SHINGLE CREEK	1980	4
27717	I 94	Shingle Creek	1980	4
27904	I 94 WB on ramp	Shingle Creek	1980	4
27810	I 94	PED PATH	1982	4
27547	CHICAGO AVE S	MINNEHAHA CREEK	1970	4
94174	BLDG(PARKING DECK)	MSAS 115 (1ST AVE N)	1989	4
82855	TH 494 EB	Mississippi R & UP RR	2003	3
95893A	5th St Gar(1st St	I 394	1986	3
20004	TH 57	S BR MID FK ZUMBRO RIVER	1996	3
27A32	4th AVE S	MIDTOWN GREENWAY	1997	3
27192	MINNEHAHA PARKWAY	MINNEHAHA CREEK	2000	2
54544	CR 129	MARSH RIVER	2000	2

Table 2: Bridges for Visual Inspection

Bridge #	Facility	Bridge Type	Year Built	Inspection Recommendation
27611	PLYMOUTH AVE	Box Girder	1980	10
27262	LRT	Box Girder	2002	10
02037 E/W	US 10 EB	Box Girder	1997	9
9350	I-94	PT Cap	1994	9
27719	LYNDALE AVE N	Box Girder	1982	8
69818 N/S	I 35 NB/SB	Box Girder	1985	8
02034	US 10 EB On Ramp	Box Girder	1996	8
9030	Blatnick (I-535)	PT Cap	1992	8
70037/70038	US 169 EB/WB	Spliced Girder	1994	7
27547	CHICAGO AVE S	Slab Span	1970	4